

# Proportional directional valves high performance

digital, direct operated, with LVDT transducer and positive spool overlap

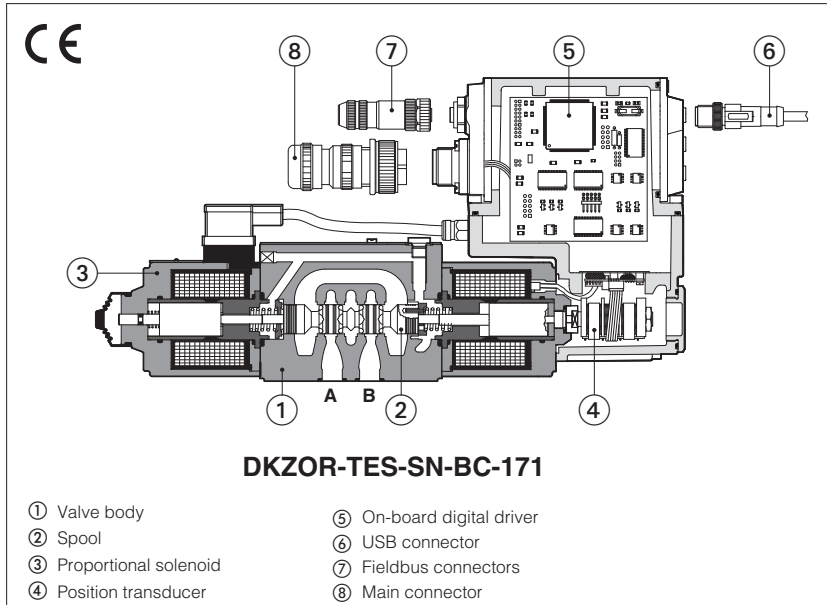

**DHZO-TEB, DHZO-TES  
DKZOR-TEB, DKZOR-TES**

High performance direct operated digital proportional valves specifically designed for high speed closed loop controls.

They are equipped with LVDT position transducer and positive spool overlap for best dynamics in directional controls and not compensated flow regulations.

**TEB** basic execution with analog reference signals and USB port for software functional parameters setting.

**TES** full execution which includes also optional alternated P/Q controls and fieldbus interfaces for functional parameters setting, reference signals and real-time diagnostics.

The on-board digital driver performs the valve's hydraulic regulation according to the reference signal and assures valve-to-valve interchangeability thanks to the factory presetting.

<b>DHZO:</b>	<b>DKZOR:</b>
Size: <b>06</b> - ISO 4401	Size: <b>10</b> - ISO 4401
Max flow: <b>80 l/min</b>	Max flow: <b>170 l/min</b>
Max pressure: <b>350 bar</b>	Max pressure: <b>315 bar</b>

**1 MODEL CODE for STANDARD SPOOLS**

<b>DHZO</b>	-	<b>TES</b>	-	<b>SN</b>	-	<b>NP</b>	-	<b>0</b>	<b>71</b>	-	<b>L</b>	<b>5</b>	/	<b>*</b>	/	<b>*</b>
<p><b>DHZO</b> = size 06 <b>DKZOR</b> = size 10</p>																<p><b>Seals material,</b> see section [11]:</p> <ul style="list-style-type: none"> <li>- = NBR</li> <li><b>PE</b> = FKM</li> <li><b>BT</b> = HNBR</li> </ul>

**TEB** = basic on-board digital driver (1)  
**TES** = full on-board digital driver

**Alternated P/Q controls, see section [6]:**

- SN** = none
- SP** = pressure control (1 pressure transducer)
- SF** = force control (2 pressure transducers)
- SL** = force control (1 load cell)

**Fieldbus interfaces, USB port always present:**

- NP** = Not present
- BC** = CANopen
- BP** = PROFIBUS DP
- EH** = EtherCAT
- EW** = POWERLINK
- EI** = EtherNet/IP
- EP** = PROFINET RT/IRT

**Valve size ISO 4401:** 0 = 06    1 = 10

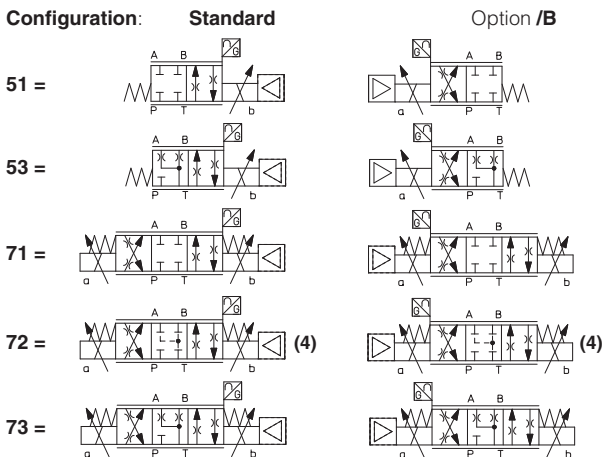

**Hydraulic options (2):**

- B** = solenoid with on-board digital driver and position transducer at side of port A
- Y** = external drain

**Electronics options (2):**

- C** = current feedback for pressure transducer 4÷20mA (omit for std voltage ±10Vdc) - only **TES-SP, SF, SL**
- F** = fault signal
- I** = current reference input and monitor 4÷20mA (omit for std voltage ±10Vdc)
- Q** = enable signal
- Z** = double power supply, enable, fault and monitor signals - 12 pin connector (3)

**Safety option TÜV certified - only TES (2):**

- U** = safe double power supply
  - K** = safe on/off acknowledge signals
- See section [7]



**Spool size: 14 (L) 1 (L) 2 (S) 3 (L,S,D) 5 (L,S,D)**

DHZO =	1	4,5	8	17	28
DKZOR =	-	-	-	45	75

Nominal flow (l/min) at Δp 10bar P-T

**Spool type, regulating characteristics:**

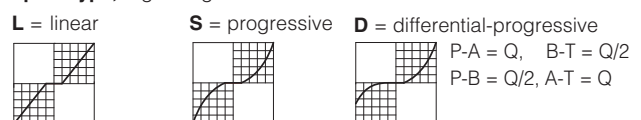

(1) Only in version **SN-NP**  
(2) For possible combined options, see section [15]  
(3) Double power supply only for **TES**

(4) Only for **DKZOR-\*S5** the spool overlapping type 2 provides the same characteristic of type 1, but in central position the internal leakages from P to A and B are drained to tank, avoiding the drift of cylinders with differential areas

**2 MODEL CODE for OPTIONAL SPOOLS** - refer to section 1, for valve model code and options

**DHZO** - **TES** - **SP** - **NP** - **0** **73 - V9** / \* \* / \*

**Configuration, spool type and size:**

**73-Q5**

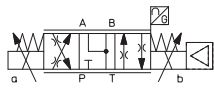

**73-Q5/B**

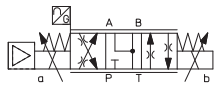

**73-V9**

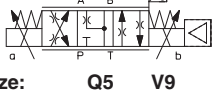

**73-V9/B**

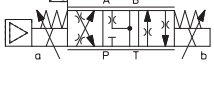

**Spool size:**      **Q5**      **V9**

DHZO      =      30      30

DKZOR      =      75      75

Nominal flow (l/min) at Δp 10 bar P-T

**Q5**

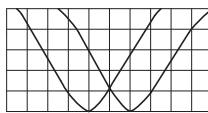

For alternate P/Q control see 12.1 - diagram 16

**V9**

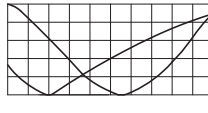

For alternate P/Q control of injection cycle in plastic machinery see 12.1 - diagram 17

**3 GENERAL NOTES**

Atos digital proportionals valves are CE marked according to the applicable directives (e.g. Immunity and Emission EMC Directive). Installation, wirings and start-up procedures must be performed according to the general prescriptions shown in tech table **F003** and in the user manuals included in the E-SW-\* programming software.

**4 VALVE SETTINGS AND PROGRAMMING TOOLS**

Valve's functional parameters and configurations, can be easily set and optimized using Atos E-SW programming software connected via USB port to the digital driver (see table **GS003**). For fieldbus versions, the software permits valve's parameterization through USB port also if the driver is connected to the central machine unit via fieldbus.

The software is available in different versions according to the driver's options (see table **GS500**):

<b>E-SW-BASIC</b>	support:	NP (USB)	PS (Serial)	IR (Infrared)
<b>E-SW-FIELDBUS</b>	support:	BC (CANopen)	BP (PROFIBUS DP)	EH (EtherCAT)
		EW (POWERLINK)	EI (EtherNet/IP)	EP (PROFINET)
<b>E-SW-*/PQ</b>	support:	valves with SP, SF, SL alternated control (e.g. E-SW-BASIC/PQ)		

**WARNING: drivers USB port is not isolated!** For E-C-SB-USB/M12 cable, the use of isolator adapter is highly recommended for PC protection

**WARNING: Bluetooth adapter is available only for European, USA and Canadian markets!** Bluetooth adapter is certified according RED (Europe), FCC (USA) and ISED (Canada) directives

**USB or Bluetooth connection**

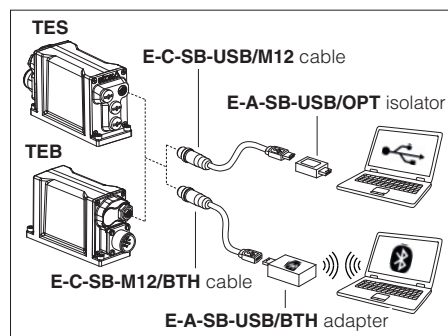

**5 FIELDBUS** - only for **TES**, see tech. table **GS510**

Fieldbus allows valve direct communication with machine control unit for digital reference, valve diagnostics and settings. These execution allow to operate the valves through fieldbus or analog signals available on the main connector.

**6 ALTERNATED P/Q CONTROLS** - only for **TES**, see tech. table **GS002**

**S\*** options add the closed loop control of pressure (**SP**) or force (**SF** and **SL**) to the basic functions of proportional directional valves flow regulation. A dedicated algorithm alternates pressure (force) depending on the actual hydraulic system conditions. An additional connector is available for transducers to be interfaced to the valve's driver (1 pressure transducer for SP, 2 pressure transducers for SF or 1 load cell for SL). The alternated pressure control (SP) is possible only for specific installation conditions. Main 12 pin connector is the same as /Z option plus two analog signals specific for the pressure (force) control.

**7 SAFETY OPTIONS** - only for **TES**

Atos range of proportional directional valves, provides functional safety options **/U** and **/K**, designed to accomplish a safety function, intended to reduce the risk in process control systems.

They are **TÜV certified** in compliance to **IEC 61508 up to SIL 3** and **ISO 13849 up to category 4, PL e**



**Safe double power supply**, option **/U**: the driver has separate power supplies for logic and solenoids. The safe condition is reached by cutting the electrical supply to solenoids, while electronics remains active for monitoring functions and fieldbus communication, see tech table **FY100**

**Safety function via on/off signals**, option **/K**: upon a disable command, the driver checks the spool position and it provides an acknowledgement signal only when the valve is in safe condition, see tech table **FY200**

**8 GENERAL CHARACTERISTICS**

Assembly position	Any position
Subplate surface finishing to ISO 4401	Acceptable roughness index: Ra ≤ 0,8, recommended Ra 0,4 – Flatness ratio 0,01/100
MTTFd valves according to EN ISO 13849	150 years, see technical table P007
Ambient temperature range	<b>Standard</b> = -20°C ÷ +60°C <b>/PE</b> option = -20°C ÷ +60°C <b>/BT</b> option = -40°C ÷ +60°C
Storage temperature range	<b>Standard</b> = -20°C ÷ +70°C <b>/PE</b> option = -20°C ÷ +70°C <b>/BT</b> option = -40°C ÷ +70°C
Surface protection	Zinc coating with black passivation (body) galvanic treatment (driver housing)
Corrosion resistance	Salt spray test (EN ISO 9227) > 200 h
Conformity	RoHs Directive 2011/65/EU as last update by 2015/65/EU REACH Regulation (EC) n°1907/2006

**9 HYDRAULIC CHARACTERISTICS** - based on mineral oil ISO VG 46 at 50 °C

Valve model	DHZO						DKZOR			
Pressure limits [bar]	ports <b>P, A, B</b> = 350; <b>T</b> = 210 (250 with external drain /Y) <b>Y</b> = 10						ports <b>P, A, B</b> = 315; <b>T</b> = 210 (250 with external drain /Y) <b>Y</b> = 10			
Configuration	<b>51, 53, 71, 73</b>						<b>51, 53, 71, 73</b>		<b>72</b>	
Spool Type	<b>L14</b>	<b>L1</b>	<b>S2</b>	<b>L3,S3,D3</b>	<b>L5,S5,D5</b>	<b>Q5,V9</b>	<b>L3,S3,D3</b>	<b>L5,S5,D5</b>	<b>Q5,V9</b>	
Nominal flow (1) [l/min] $\Delta p = 10$ bar	1	4,5	8	18	28	30	45	75	75	
$\Delta p$ P-T	$\Delta p = 30$ bar	1,7	8	14	30	50	52	80	130	45
	$\Delta p = 70$ bar	2,6	12	21	45	75	80	120	170	170
Max flow (2)	4	18	30	50	80	80	130	180	180	
Leakage [cm <sup>3</sup> /min]	<30 (at p = 100 bar); <135 (at p = 350 bar)						<80 (at p = 100 bar); <600 (at p = 315 bar)			
Response time (3) [ms]	≤ 15						≤ 20			
Hysteresis	≤ 0,2 [% of max regulation]									
Repeatability	± 0,1 [% of max regulation]									
Thermal drift	zero point displacement < 1% at $\Delta T = 40^\circ C$									

(1) For different  $\Delta p$ , the max flow is in accordance to the diagrams in section 12.2

(2) See detailed diagrams in section 12.3

(3) 0-100% step signal

**10 ELECTRICAL CHARACTERISTICS**

Power supplies	Nominal : +24 VDC Rectified and filtered : $V_{RMS} = 20 \div 32 V_{MAX}$ (ripple max 10 % $V_{PP}$ )			
Max power consumption	50 W			
Max. solenoid current	DHZO = 2,6 A		DKZOR = 3 A	
Coil resistance R at 20°C	DHZO = 3 ÷ 3,3 Ω		DKZOR = 3,8 ÷ 4,1 Ω	
Analog input signals	Voltage: range ±10 VDC (24 $V_{MAX}$ tollerant) Current: range ±20 mA		Input impedance: $R_i > 50$ kΩ Input impedance: $R_i = 500$ Ω	
Monitor outputs	Output range: voltage ±10 VDC @ max 5 mA current ±20 mA @ max 500 Ω load resistance			
Enable input	Range: 0 ÷ 5 VDC (OFF state), 9 ÷ 24 VDC (ON state), 5 ÷ 9 VDC (not accepted); Input impedance: $R_i > 10$ kΩ			
Fault output	Output range: 0 ÷ 24 Vdc (ON state > [power supply - 2 V] ; OFF state < 1 V ) @ max 50 mA; external negative voltage not allowed (e.g. due to inductive loads)			
Pressure/Force transducer power supply (only for SP, SF, SL)	+24Vdc @ max 100 mA (E-ATR-8 see tech table <b>GS465</b> )			
Alarms	Solenoid not connected/short circuit, cable break with current reference signal, over/under temperature, valve spool transducer malfunctions, alarms history storage function			
Insulation class	H (180°) Due to the occurring surface temperatures of the solenoid coils, the European standards ISO 13732-1 and EN982 must be taken into account			
Protection degree to DIN EN60529	IP66 / IP67 with mating connectors			
Duty factor	Continuous rating (ED=100%)			
Tropicalization	Tropical coating on electronics PCB			
Additional characteristics	Short circuit protection of solenoid's current supply; 3 leds for diagnostic; spool position control (SN) or pressure/force control (SP, SF, SL) by P.I.D. with rapid solenoid switching; protection against reverse polarity of power supply			
Electromagnetic compatibility (EMC)	According to Directive 2014/30/UE (Immunity: EN 61000-6-2; Emission: EN 61000-6-3)			
Communication interface	USB Atos ASCII coding	CANopen EN50325-4 + DS408	PROFIBUS DP EN50170-2/IEC61158	EtherCAT, POWERLINK, EtherNet/IP, PROFINET IO RT / IRT EC 61158
Communication physical layer	not insulated USB 2.0 + USB OTG	optical insulated CAN ISO11898	optical insulated RS485	Fast Ethernet, insulated 100 Base TX
Recommended wiring cable	LiYCY shielded cables, see section 19			

**Note:** a maximum time of 800 ms (depending on communication type) have be considered between the driver energizing with the 24 Vdc power supply and when the valve is ready to operate. During this time the current to the valve coils is switched to zero.

**11 SEALS AND HYDRAULIC FLUIDS** - for other fluids not included in below table, consult our technical office

Seals, recommended fluid temperature	NBR seals (standard) = -20°C ÷ +60°C, with HFC hydraulic fluids = -20°C ÷ +50°C FKM seals (/PE option) = -20°C ÷ +80°C HNBR seals (/BT option) = -40°C ÷ +60°C, with HFC hydraulic fluids = -40°C ÷ +50°C		
Recommended viscosity	20÷100 mm <sup>2</sup> /s - max allowed range 15 ÷ 380 mm <sup>2</sup> /s		
Max fluid contamination level	normal operation	ISO4406 class 18/16/13 NAS1638 class 7	see also filter section at
	longer life	ISO4406 class 16/14/11 NAS1638 class 5	www.atos.com or KTF catalog
<b>Hydraulic fluid</b>	<b>Suitable seals type</b>	<b>Classification</b>	<b>Ref. Standard</b>
Mineral oils	NBR, FKM, HNBR	HL, HLP, HLPD, HVLP, HVLPD	DIN 51524
Flame resistant without water	FKM	HFDU, HFDR	ISO 12922
Flame resistant with water	NBR, HNBR	HFC	

**12 DIAGRAMS** - based on mineral oil ISO VG 46 at 50 °C

**12.1 Regulation diagrams** - values measure at  $\Delta p$  30 bar P-T

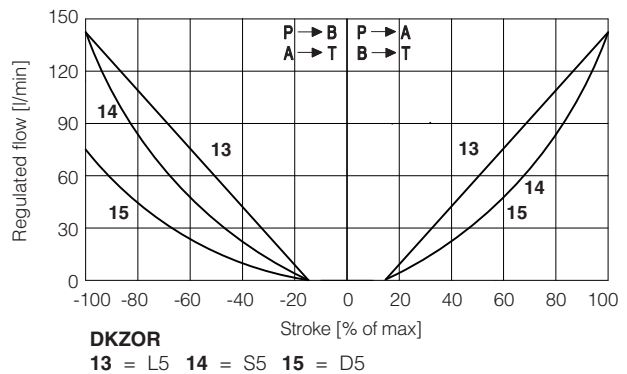
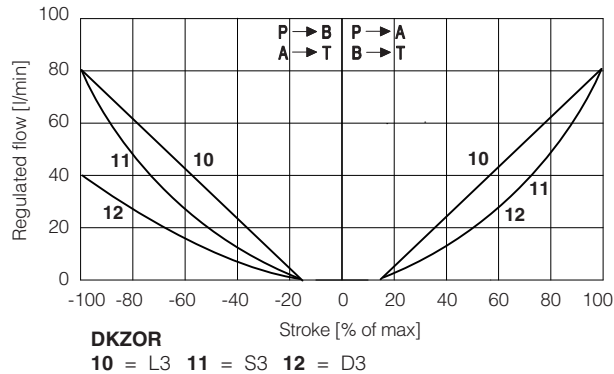
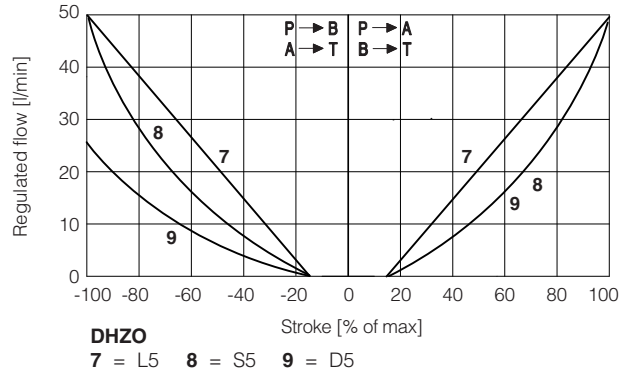
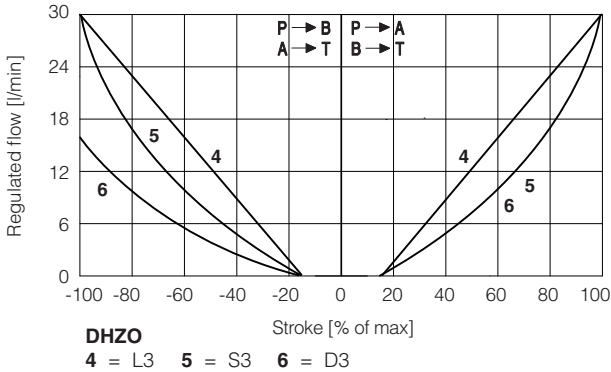
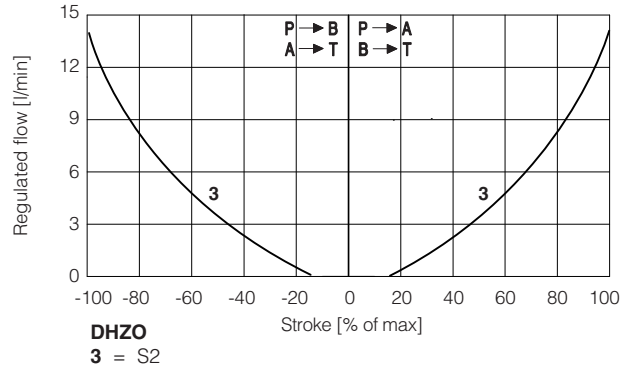
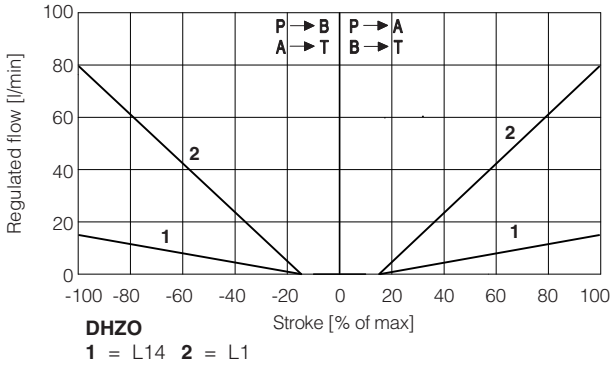

**Note:**

Hydraulic configuration vs. reference signal for configurations 71, 72 and 73 (standard and option /B)

Reference signal  $\left. \begin{matrix} 0 \div +10 \text{ V} \\ 12 \div 20 \text{ mA} \end{matrix} \right\} P \rightarrow A / B \rightarrow T$

Reference signal  $\left. \begin{matrix} 0 \div -10 \text{ V} \\ 12 \div 4 \text{ mA} \end{matrix} \right\} P \rightarrow B / A \rightarrow T$

**16** = linear spool **Q5**

Q5 spool type is specific for alternate P/Q controls in combination with S\* option of digital integral drivers (see tech table **GS002**). It allows to control the pressure in A port or B port and it provides a safety central position (A-T/B-T) to depressurize the actuator chambers.

The strong meter-in characteristic makes the spool suitable for both pressure control and motion regulations in several applications.

**17** = differential - progressive spool **V9**

V9 spool type is specific for alternate P/Q controls in combination with S\* option of digital integral drivers (see tech table **GS002**). This spool is specially designed to manage the whole injection cycle in plastic machinery, thanks to the following specific features:

- strong meter-in characteristic to allow the pressure control in A port during the holding pressure (P-A) and the plasticizing (A-T) phases
- safety central position (A-T/B-T) to depressurize the actuator chambers
- large A-T and B-T flow capability, required during the plasticizing phase, to discharge big volumes from high differential injection cylinders with low pressure drops and permitting the contemporary oil suction from tank

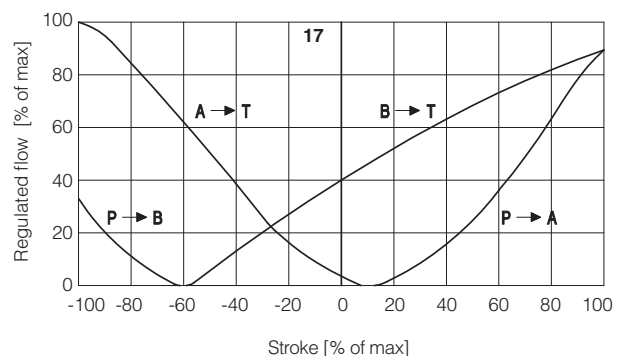
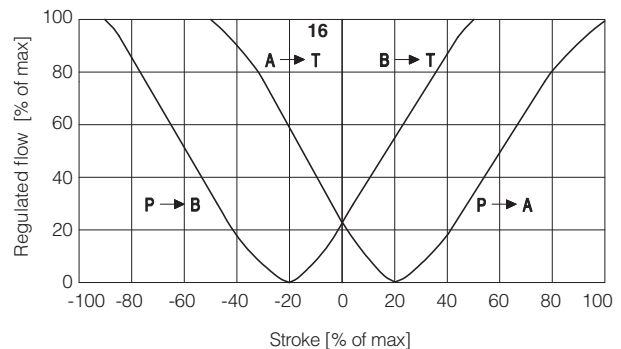

### 12.2 Flow / $\Delta p$ diagrams

stated at 100% of valve stroke

#### DHZO

- 1 = spool L14
- 2 = spool L1
- 3 = spool S2
- 4 = spool L3, S3, D3
- 5 = spool L5, S5, D5, V9

#### DKZOR

- 6 = spool S3, L3, D3
- 7 = spool S5, L5, D5, V9

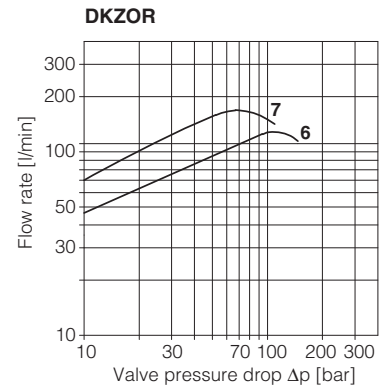
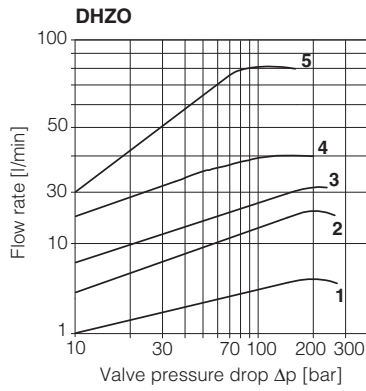

### 12.3 Operating limits

#### DHZO

- 1 = spool L14
- 2 = spool L1
- 3 = spool S2
- 4 = spool L3, S3, D3
- 5 = spool L5, S5, D5, V9

#### DKZOR

- 6 = spool S3, L3, D3
- 7 = spool S5, L5, D5, V9

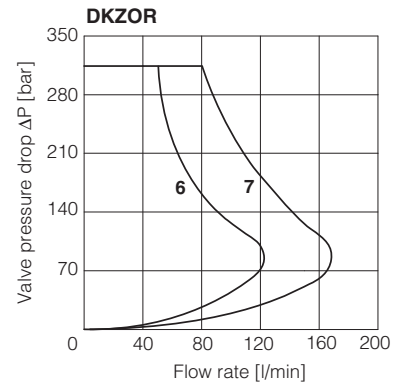
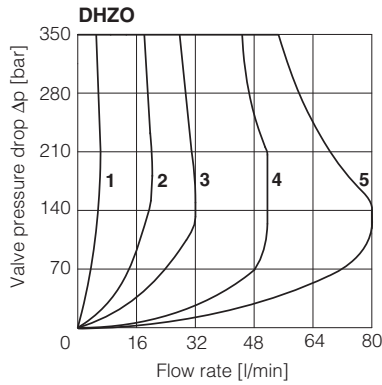

### 12.4 Response time

The response times in below diagrams are measured at different steps of the reference input signal. They have to be considered as average values. For the valves with digital electronics the dynamics performances can be optimized by setting the internal software parameters.

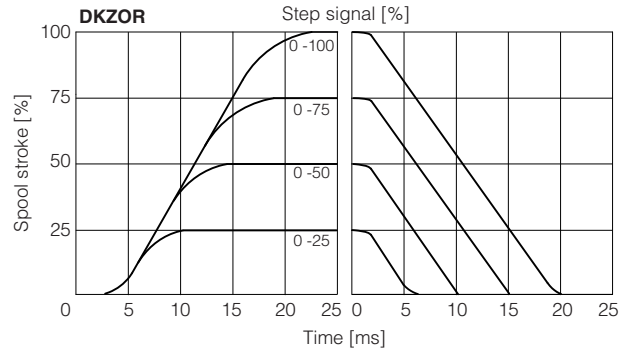
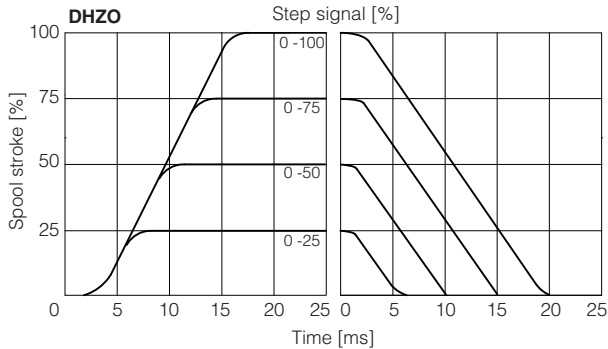

### 12.5 Bode diagrams

- 1 = 10% ↔ 90% nominal stroke
- 2 = 50% ± 5% nominal stroke

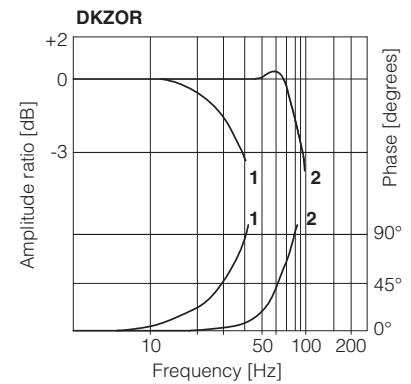
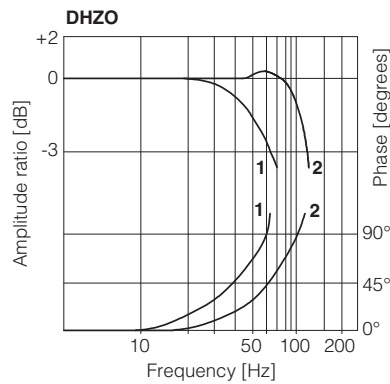

### 12.6 Operation as throttle valve

Single solenoid valves configuration  
51 and 53 can be used as simple throttle valves:  
 $P_{max} = 250$  bar (option /Y advisable)

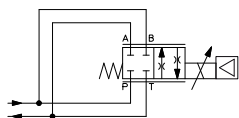

Max flow $\Delta p = 30$ bar [l/min]	SPOOL TYPE				
	L14	L1	S2	L3 S3	L5 S5
<b>DHZO</b>	4	16	28	60	100
<b>DKZOR</b>	-	-	-	160	260

## 13 HYDRAULIC OPTIONS

- B** = Solenoid, on-board digital driver and position transducer at side of port A of the main stage. For hydraulic configuration vs reference signal, see 12.1
- Y** = This option is mandatory if the pressure in port T exceeds 210 bar.

## 14 ELECTRONICS OPTIONS

- F** = This option permits to monitor the eventual fault condition of the driver, as for example the solenoid short circuit/not connected, reference signal cable broken for option /I, spool position transducer broken, etc. - see 16.9 for signal specifications.
- I** = This option provides 4 ÷ 20 mA current reference and monitor signals, instead of the standard ±10 Vdc.  
Input signal can be reconfigured via software selecting between voltage and current, within a maximum range of ±10 Vdc or ±20 mA.  
It is normally used in case of long distance between the machine control unit and the valve or where the reference signal can be affected by electrical noise; the valve functioning is disabled in case of reference signal cable breakage.
- Q** = This option permits to inhibit the valve function without removing the power supply to the driver. Upon disable command the current to the solenoid is zeroed and the valve's spool moves to rest position.  
The option /Q is suggested for all cases where the valve has to be frequently inhibited during the machine cycle – see 16.7 for signal specifications.
- Z** = This option provides, on the 12 pin main connector, the following additional features:  
**Fault output signal** - see above option /F  
**Enable input signal** - see above option /Q  
**Repeat enable output signal** - only for **TEB** (see 16.8)  
**Power supply for driver's logics and communication** - only for **TES** (see 16.2)
- C** = This option is available to connect pressure (force) transducers with 4 ÷ 20 mA current output signal, instead of the standard ±10 Vdc.  
Input signal can be reconfigured via software selecting between voltage and current, within a maximum range of ±10 Vdc or ±20 mA.

## 15 POSSIBLE COMBINED OPTIONS

### Standard versions for **TEB-SN** and **TES-SN**:

/BF, /BFI, /BFIY, /BFY, /BI, /BIQ, /BIQY, /BIY, /BIYZ, /BIZ, /BQ,  
/BQY /BY, /BYZ, /BZ,  
/FI, /FIY, /FY, /IQ, /IQY,  
/IY, /IYZ, /IZ,  
/QY, /YZ

### Standard versions for **TES-SP, SF, SL**:

/BC, /BCI, /BCIY, /BCY, /BI, /BIY, /BY,  
/CI, /CIY, /CY,  
/IY

### Safety certified versions for **TES-SN**:

/BIU, /BIUY, /BU, /BUY, /IU, /IUY, /IY,  
/BIK, /BIKY, /BK, /BKY, /IK, /IKY, /KY

### Safety certified versions for **TES-SP, SF, SL**:

/BCU, /BCIU, /BCIUY, /BCUY, /BIU, /BIUY, /BU, /BUY,  
/CU, /CIU, /CIUY, /CUY, /IU, /IUY, /IY,  
/BCK, /BCKI, /BCKIY, /BCKY, /BIK, /BIKY, /BK, /BKY,  
/CK, /CIK, /CIKY, /CKY, /IK, /IKY, /KY

## 16 POWER SUPPLY AND SIGNALS SPECIFICATIONS

Generic electrical output signals of the valve (e.g. fault or monitor signals) must not be directly used to activate safety functions, like to switch-ON/OFF the machine's safety components, as prescribed by the European standards (Safety requirements of fluid technology systems and components-hydraulics, EN-982).

For certified safety options: /U see tech. table **FY100** and /K see tech. table **FY200**

### 16.1 Power supply (V+ and V0)

The power supply must be appropriately stabilized or rectified and filtered: apply at least a 10000 µF/40 V capacitance to single phase rectifiers or a 4700 µF/40 V capacitance to three phase rectifiers. In case of separate power supply see 16.2.



A safety fuse is required in series to each power supply: 2,5 A time lag fuse.

### 16.2 Power supply for driver's logic and communication (VL+ and VL0) - only for /Z option and **TES-SP, SF, SL** with fieldbus

The power supply for driver's logic and communication must be appropriately stabilized or rectified and filtered: apply at least a 10000 µF/40 V capacitance to single phase rectifiers or a 4700 µF/40 V capacitance to three phase rectifiers.

The separate power supply for driver's logic on pin 9 and 10, allow to remove solenoid power supply from pin 1 and 2 maintaining active the diagnostics, USB and fieldbus communications.



A safety fuse is required in series to each driver's logic and communication power supply: 500 mA fast fuse.

### 16.3 Flow reference input signal (Q\_INPUT+)

The driver controls in closed loop the valve spool position proportionally to the external reference input signal.

Reference input signal is factory preset according to selected valve code, defaults are ±10 Vdc for standard and 4 ÷ 20 mA for /I option.

Input signal can be reconfigured via software selecting between voltage and current, within a maximum range of ±10 Vdc or ±20 mA.

Drivers with fieldbus interface can be software set to receive reference signal directly from the machine control unit (fieldbus reference). Analog reference input signal can be used as on-off commands with input range 0 ÷ 24Vdc.

### 16.4 Pressure or force reference input signal (F\_INPUT+) - only for **TES-SP, SF, SL**

Functionality of F\_INPUT+ signal (pin 7), is used as reference for the driver pressure/force closed loop (see tech. table **GS002**).

Reference input signal is factory preset according to selected valve code, defaults are ±10 Vdc for standard and 4 ÷ 20 mA for /I option.

Input signal can be reconfigured via software selecting between voltage and current, within a maximum range of ±10 Vdc or ±20 mA.

Drivers with fieldbus interface can be software set to receive reference signal directly by the machine control unit (fieldbus reference).

Analog reference input signal can be used as on-off commands with input range 0 ÷ 24Vdc.

### 16.5 Flow monitor output signal (Q\_MONITOR) - not for /F

The driver generates an analog output signal proportional to the actual spool position of the valve; the monitor output signal can be software set to show other signals available in the driver (e.g. analog reference, fieldbus reference, pilot spool position).

Monitor output signal is factory preset according to selected valve code, defaults are ±10 Vdc for standard and 4 ÷ 20 mA for /I option.

Output signal can be reconfigured via software selecting between voltage and current, within a maximum range of ±10 Vdc or ±20 mA.

### 16.6 Pressure or force monitor output signal (F\_MONITOR) - only for **TES-SP, SF, SL**

The driver generates an analog output signal proportional to alternated pressure/force control; the monitor output signal can be software set to show other signals available in the driver (e.g. analog reference, force reference).

Monitor output signal is factory preset according to selected valve code, defaults are ±10 Vdc for standard and 4 ÷ 20 mA for /I option.

Output signal can be reconfigured via software selecting between voltage and current, within a maximum range of ±10 Vdc or ±20 mA.

**16.7 Enable input signal (ENABLE) - not for standard and /F**

To enable the driver, supply a 24 Vdc on pin 3 (pin C): Enable input signal allows to enable/disable the current supply to the solenoid, without removing the electrical power supply to the driver; it is used to active the communication and the other driver functions when the valve must be disabled for safety reasons. This condition **does not comply** with norms IEC 61508 and ISO 13849. Enable input signal can be used as generic digital input by software selection.

**16.8 Repeat enable output signal (R\_ENABLE) - only for TEB with /Z option**

Repeat enable is used as output repeater signal of enable input signal (see 16.7).

**16.9 Fault output signal (FAULT) - not for standard and /Q**

Fault output signal indicates fault conditions of the driver (solenoid short circuits/not connected, reference signal cable broken for 4 ÷ 20 mA input, spool position transducer cable broken, etc.). Fault presence corresponds to 0 Vdc, normal working corresponds to 24 Vdc. Fault status is not affected by the Enable input signal. Fault output signal can be used as digital output by software selection.

**16.10 Remote pressure/force transducer input signal - only for TES-SP, SF, SL**

Analog remote pressure transducers or load cell can be directly connected to the driver (see 17.4). Analog input signal is factory preset according to selected valve code, defaults are ±10 Vdc for standard and 4 ÷ 20 mA for /C option. Input signal can be reconfigured via software selecting between voltage and current, within a maximum range of ±10 Vdc or ± 20 mA. Refer to pressure/force transducer characteristics to select the transducer type according to specific application requirements (see tech table **GS002**).

**16.11 Multiple PID selection (D\_IN0 and D\_IN1) - only NP execution for TES-SP, SF, SL**

Two on-off input signals are available on the main connector to select one of the four pressure (force) PID parameters setting, stored into the driver. Switching the active setting of pressure PID during the machine cycle allows to optimize the system dynamic response in different hydraulic working conditions (volume, flow, etc.). Supply a 24 Vdc or a 0 Vdc on pin 9 and/or pin 10, to select one of the PID settings as indicated by binary code table at side. Gray code can be selected by software.

PIN	PID SET SELECTION			
	SET 1	SET 2	SET 3	SET 4
9	0	24 Vdc	0	24 Vdc
10	0	0	24 Vdc	24 Vdc

**17 ELECTRONIC CONNECTIONS**

**17.1 Main connector signals - 7 pin (A1) Standard, /Q and /F options**

PIN	Standard	/Q	/F	TECHNICAL SPECIFICATIONS	NOTES
A	<b>V+</b>			Power supply 24 Vdc	Input - power supply
B	<b>V0</b>			Power supply 0 Vdc	Gnd - power supply
C	<b>AGND</b>		<b>AGND</b>	Analog ground	Gnd - analog signal
		<b>ENABLE</b>		Enable (24 Vdc) or disable (0 Vdc) the valve, referred to V0	Input - on/off signal
D	<b>Q_INPUT+</b>			Flow reference input signal: ±10 Vdc / ±20 mA maximum range Defaults are ±10 Vdc for standard and 4 ÷ 20 mA for /I option	Input - analog signal <b>Software selectable</b>
E	<b>INPUT-</b>			Negative reference input signal for Q_INPUT+	Input - analog signal
F	<b>Q_MONITOR</b> referred to:			Flow monitor output signal: ±10 Vdc / ±20 mA maximum range Defaults are ±10 Vdc for standard and 4 ÷ 20 mA for /I option	Output - analog signal <b>Software selectable</b>
	AGND	V0	<b>FAULT</b>	Fault (0 Vdc) or normal working (24 Vdc)	Output - on/off signal
G	<b>EARTH</b>			Internally connected to the driver housing	

**17.2 Main connector signals - 12 pin (A2) /Z option and TES-SP, SF, SL**

PIN	TEB-SN /Z	TES-SN /Z	TES-SP, SF, SL Fieldbus NP		TECHNICAL SPECIFICATIONS	NOTES
1	<b>V+</b>				Power supply 24 Vdc	Input - power supply
2	<b>V0</b>				Power supply 0 Vdc	Gnd - power supply
3	<b>ENABLE</b> referred to:				Enable (24 Vdc) or disable (0 Vdc) the valve	Input - on/off signal
	V0	VL0	VL0	V0		
4	<b>Q_INPUT+</b>				Flow reference input signal: ±10 Vdc / ±20 mA maximum range Defaults are ±10 Vdc for standard and 4 ÷ 20 mA for /I option	Input - analog signal <b>Software selectable</b>
5	<b>INPUT-</b>				Negative reference input signal for Q_INPUT+ and F_INPUT+	Input - analog signal
6	<b>Q_MONITOR</b> referred to:				Flow monitor output signal: ±10 Vdc / ±20 mA maximum range Defaults are ±10 Vdc for standard and 4 ÷ 20 mA for /I option	Output - analog signal <b>Software selectable</b>
	AGND	VL0	VL0	V0		
7	<b>AGND</b>				Analog ground	Gnd - analog signal
		<b>NC</b>			Do not connect	
			<b>F_INPUT+</b>		Pressure/Force reference input signal: ±10 Vdc / ±20 mA maximum range Defaults are ±10 Vdc for standard and 4 ÷ 20 mA for /I option	Input - analog signal <b>Software selectable</b>
	<b>R_ENABLE</b>				Repeat enable, output repeter signal of enable input, referred to V0	Output - on/off signal
8		<b>NC</b>			Do not connect	
			<b>F_MONITOR</b> referred to:		Pressure/Force monitor output signal: ±10 Vdc / ±20 mA maximum range Defaults are ±10 Vdc for standard and 4 ÷ 20 mA for /I option	Output - analog signal <b>Software selectable</b>
9					Do not connect	
		<b>VL+</b>			Power supply 24 Vdc for driver's logic and communication	Input - power supply
10				<b>D_IN0</b>	Multiple pressure/force PID selection, referred to V0	Input - analog signal
	<b>NC</b>				Do not connect	
		<b>VL0</b>			Power supply 0 Vdc for driver's logic and communication	Gnd - power supply
				<b>D_IN1</b>	Multiple pressure/force PID selection (not available for SF), referred to V0	Input - on/off signal
11	<b>FAULT</b> referred to:				Fault (0 Vdc) or normal working (24 Vdc)	Output - on/off signal
	V0	VL0	VL0	V0		
PE	<b>EARTH</b>				Internally connected to the driver housing	

**Note:** do not disconnect VL0 before VL+ when the driver is connected to PC USB port

### 17.3 Communications connectors (B) - (C)

(B) USB connector - M12 - 5 pin always present		
PIN	SIGNAL	TECHNICAL SPECIFICATION (1)
1	+5V_USB	Power supply
2	ID	Identification
3	GND_USB	Signal zero data line
4	D-	Data line -
5	D+	Data line +

(C1) (C2) BP fieldbus execution, connector - M12 - 5 pin		
PIN	SIGNAL	TECHNICAL SPECIFICATION (1)
1	+5V	Termination supply signal
2	LINE-A	Bus line (high)
3	DGND	Data line and termination signal zero
4	LINE-B	Bus line (low)
5	SHIELD	

(C1) (C2) BC fieldbus execution, connector - M12 - 5 pin		
PIN	SIGNAL	TECHNICAL SPECIFICATION (1)
1	CAN_SHLD	Shield
2	not used	(C1) - (C2) pass-through connection (2)
3	CAN_GND	Signal zero data line
4	CAN_H	Bus line (high)
5	CAN_L	Bus line (low)

(C1) (C2) EH, EW, EI, EP fieldbus execution, connector - M12 - 4 pin		
PIN	SIGNAL	TECHNICAL SPECIFICATION (1)
1	TX+	Transmitter
2	RX+	Receiver
3	TX-	Transmitter
4	RX-	Receiver
Housing	SHIELD	

(1) Shield connection on connector's housing is recommended

(2) Pin 2 can be fed with external +5V supply of CAN interface

### 17.4 Remote pressure/force transducer connector - M12 - 5 pin - only for SP, SF, SL (D)

PIN	SIGNAL	TECHNICAL SPECIFICATION	NOTES	(D1) SP, SL - Single transducer (1)		(D2) SF - Double transducers (1)	
				Voltage	Current	Voltage	Current
1	VF +24V	Power supply +24Vdc	Output - power supply	Connect	Connect	Connect	Connect
2	TR1	1st signal transducer: ±10 Vdc / ±20 mA maximum range	Input - analog signal <b>Software selectable</b>	Connect	Connect	Connect	Connect
3	AGND	Common gnd for transducer power and signals	Common gnd	Connect	/	Connect	/
4	TR2	2nd signal transducer: ±10 Vdc / ±20 mA maximum range	Input - analog signal <b>Software selectable</b>	/	/	Connect	Connect
5	NC	Not connect		/	/	/	/

(1) Single/double transducer configuration is software selectable

### Remote pressure transducers connection - example

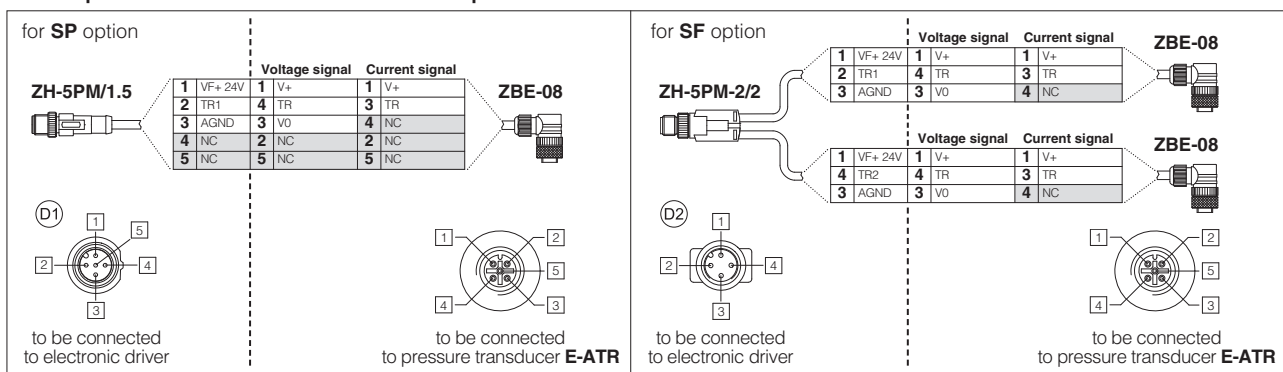

Note: pin layout always referred to driver's view

### 17.5 TEB connections layout

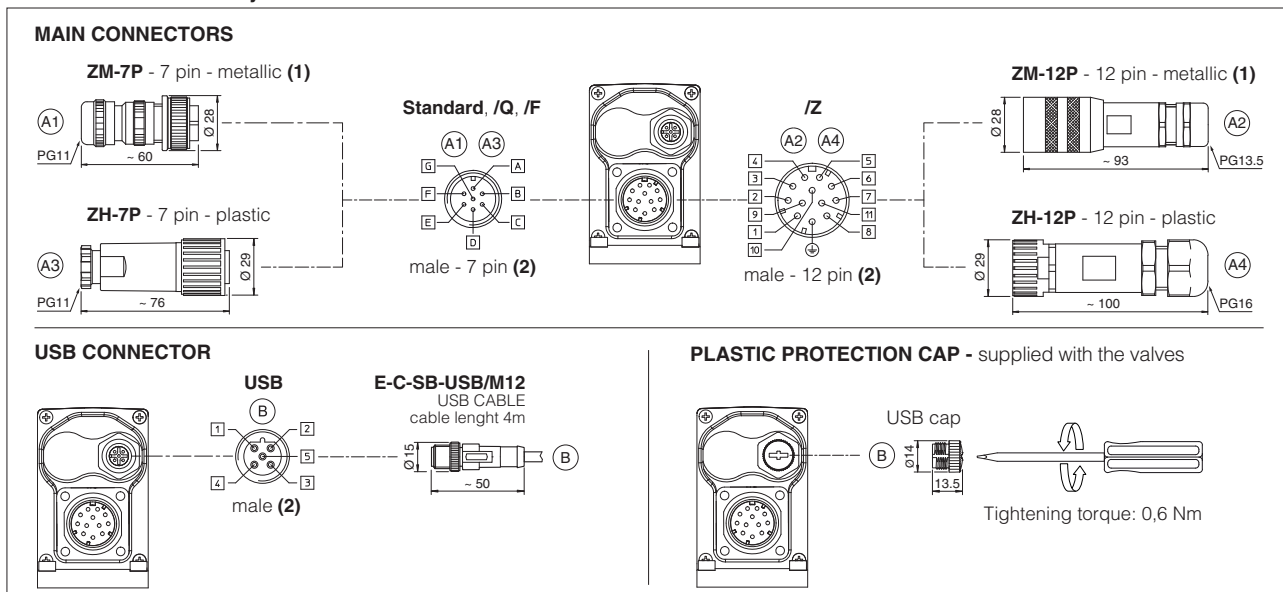

(1) Use of metallic connectors is strongly recommended in order to fulfill EMC requirements

(2) Pin layout always referred to driver's view

## 17.6 TES connections layout

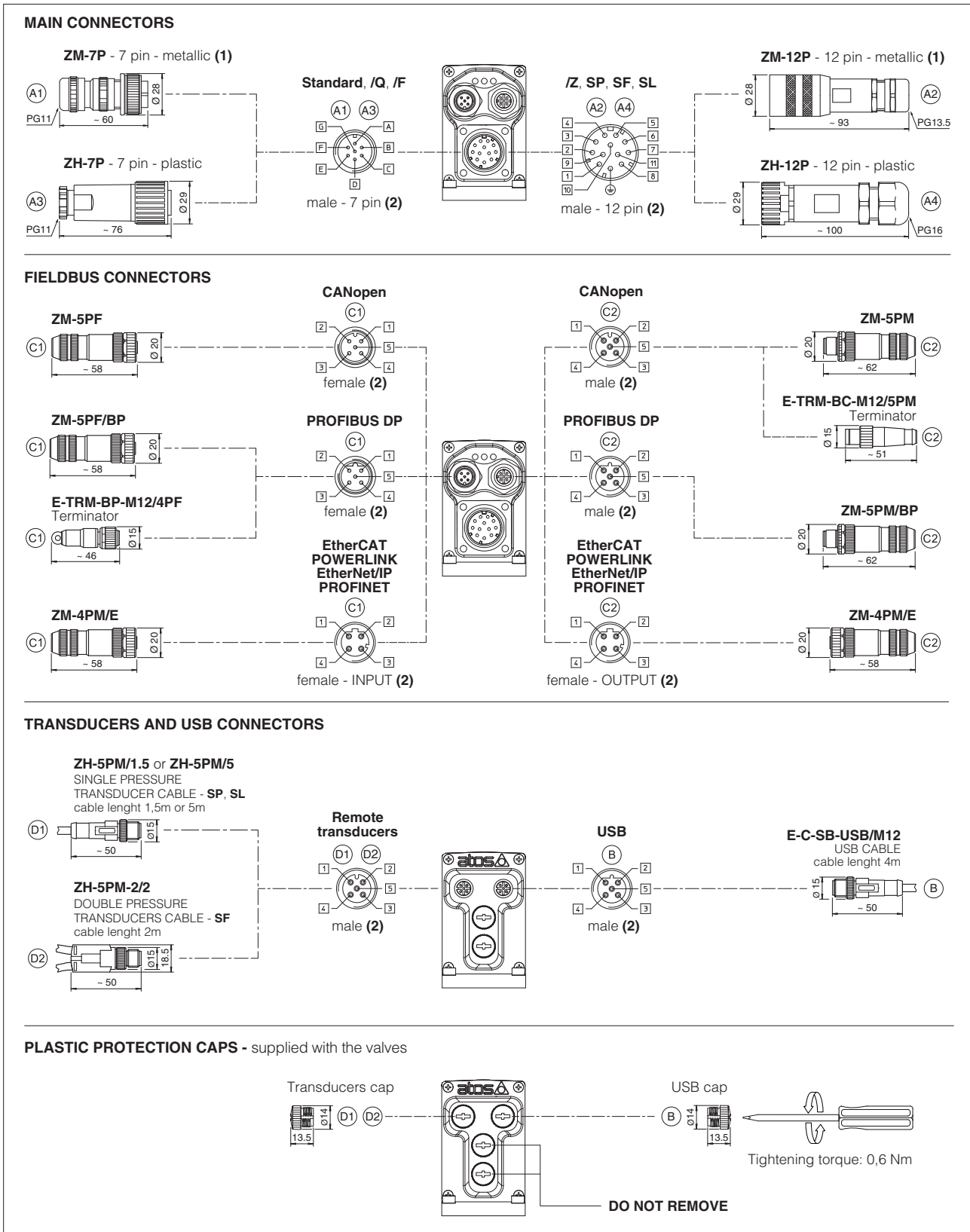

(1) Use of metallic connectors is strongly recommended in order to fulfill EMC requirements (2) Pin layout always referred to driver's view

## 17.7 Diagnostic LEDs - only for TES

Three leds show driver operative conditions for immediate basic diagnostics. Please refer to the driver user manual for detailed information.

FIELDBUS LEDS	NP Not Present	BC CANopen	BP PROFIBUS DP	EH EtherCAT	EW POWERLINK	EI EtherNet/IP	EP PROFINET	L1 L2 L3
L1		VALVE STATUS			LINK/ACT			
L2		NETWORK STATUS			NETWORK STATUS			
L3		SOLENOID STATUS			LINK/ACT			

## 18 IN / OUT FIELDBUS COMMUNICATION CONNECTORS

Two fieldbus communication connectors are always available for digital drivers executions BC, BP, EH, EW, EI, EP. This features allows considerable technical advantages in terms of installation simplicity, wirings reduction and also avoid the usage expensive T-connectors.

For BC and BP executions the fieldbus connectors have an internal pass-through connection and can be used like end point of the fieldbus network, using an external terminator (see tech table **GS500**).

For EH, EW, EI and EP executions the external terminators are not required: each connector is internally terminated.

### BC and BP pass-through connection

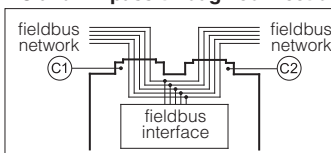

## 19 CONNECTORS CHARACTERISTICS - to be ordered separately

### 19.1 Main connectors - 7 pin

CONNECTOR TYPE	POWER SUPPLY	POWER SUPPLY
<b>CODE</b>	<b>(A1) ZM-7P</b>	<b>(A3) ZH-7P</b>
Type	7pin female straight circular	7pin female straight circular
Standard	According to MIL-C-5015	According to MIL-C-5015
Material	Metallic	Plastic reinforced with fiber glass
Cable gland	PG11	PG11
Recommended cable	LiYCY 7 x 0,75 mm <sup>2</sup> max 20 m (logic and power supply) or LiYCY 7 x 1 mm <sup>2</sup> max 40 m (logic and power supply)	LiYCY 7 x 0,75 mm <sup>2</sup> max 20 m (logic and power supply) or LiYCY 7 x 1 mm <sup>2</sup> max 40 m (logic and power supply)
Conductor size	up to 1 mm <sup>2</sup> - available for 7 wires	up to 1 mm <sup>2</sup> - available for 7 wires
Connection type	to solder	to solder
Protection (EN 60529)	IP 67	IP 67

### 19.2 Main connectors - 12 pin

CONNECTOR TYPE	POWER SUPPLY	POWER SUPPLY
<b>CODE</b>	<b>(A2) ZM-12P</b>	<b>(A4) ZH-12P</b>
Type	12pin female straight circular	12pin female straight circular
Standard	DIN 43651	DIN 43651
Material	Metallic	Plastic reinforced with fiber glass
Cable gland	PG13,5	PG16
Recommended cable	LiYCY 12 x 0,75 mm <sup>2</sup> max 20 m (logic and power supply)	LiYCY 10 x 0,14mm <sup>2</sup> max 40 m (logic) LiYY 3 x 1mm <sup>2</sup> max 40 m (power supply)
Conductor size	0,5 mm <sup>2</sup> to 1,5 mm <sup>2</sup> - available for 12 wires	0,14 mm <sup>2</sup> to 0,5 mm <sup>2</sup> - available for 9 wires 0,5 mm <sup>2</sup> to 1,5 mm <sup>2</sup> - available for 3 wires
Connection type	to crimp	to crimp
Protection (EN 60529)	IP 67	IP 67

### 19.3 Fieldbus communication connectors

CONNECTOR TYPE	BC CANopen (1)		BP PROFIBUS DP (1)		EH EtherCAT, EW POWERLINK, EI EtherNet/IP, EP PROFINET (2)	
<b>CODE</b>	<b>(C1) ZM-5PF</b>	<b>(C2) ZM-5PM</b>	<b>(C1) ZM-5PF/BP</b>	<b>(C2) ZM-5PM/BP</b>	<b>(C1) (C2) ZM-4PM/E</b>	
Type	5 pin female straight circular	5 pin male straight circular	5 pin female straight circular	5 pin male straight circular	4 pin male straight circular	
Standard	M12 coding A – IEC 61076-2-101		M12 coding B – IEC 61076-2-101		M12 coding D – IEC 61076-2-101	
Material	Metallic		Metallic		Metallic	
Cable gland	Pressure nut - cable diameter 6÷8 mm		Pressure nut - cable diameter 6÷8 mm		Pressure nut - cable diameter 4÷8 mm	
Cable	CANbus Standard (DR 303-1)		PROFIBUS DP Standard		Ethernet standard CAT-5	
Connection type	screw terminal		screw terminal		terminal block	
Protection (EN 60529)	IP67		IP 67		IP 67	

(1) E-TRM-\*\* terminators can be ordered separately - see tech table **GS500**

(2) Internally terminated

### 19.4 Pressure/Force transducer connectors - only for SP, SF, SL

CONNECTOR TYPE	SP, SL - Single transducer		SF - Double transducers
<b>CODE</b>	<b>(D1) ZH-5PM/1.5</b>	<b>(D1) ZH-5PM/5</b>	<b>(D2) ZH-5PM-2/2</b>
Type	5 pin male straight circular		4 pin male straight circular
Standard	M12 coding A – IEC 61076-2-101		M12 coding A – IEC 61076-2-101
Material	Plastic		Plastic
Cable gland	Connector moulded on cables 1,5 m lenght   5 m lenght		Connector moulded on cables 2 m lenght
Cable	5 x 0,25 mm <sup>2</sup>		3 x 0,25 mm <sup>2</sup> (both cables)
Connection type	molded cable		splitting cable
Protection (EN 60529)	IP 67		IP 67

## 20 FASTENING BOLTS AND SEALS

	DHZO	DKZOR
	<p><b>Fastening bolts:</b></p> <p>4 socket head screws M5x50 class 12.9 Tightening torque = 8 Nm</p>	<p><b>Fastening bolts:</b></p> <p>4 socket head screws M10x45 class 12.9 Tightening torque = 70 Nm</p>
	<p><b>Seals:</b></p> <p>4 OR 108; Diameter of ports A, B, P, T: Ø 7,5 mm (max) 1 OR 2025 Diameter of port Y: Ø = 3,2 mm (only for /Y option)</p>	<p><b>Seals:</b></p> <p>5 OR 2050; Diameter of ports A, B, P, T: Ø 11,2 mm (max) 1 OR 108 Diameter of port Y: Ø = 5 mm (only for /Y option)</p>

## DHZO-TEB, DHZO-TES

ISO 4401: 2000

Mounting surface: 4401-03-02-0-05 (see table P005)  
(for /Y surface 4401-03-03-0-05 without X port)

Mass [kg]	
DHZO-*-05	2,3
DHZO-*-07	3,1

DHZO-TEB-\*-05  
DHZO-TES-\*-05

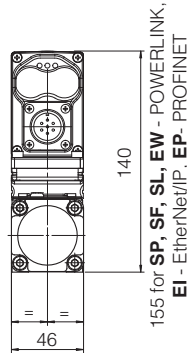
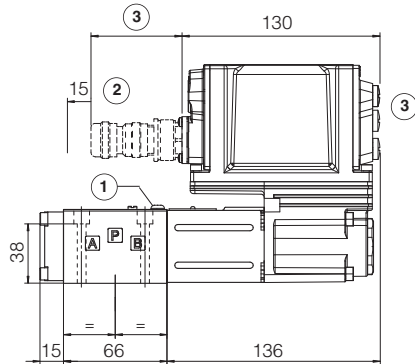

DHZO-TEB-\*-07  
DHZO-TES-\*-07

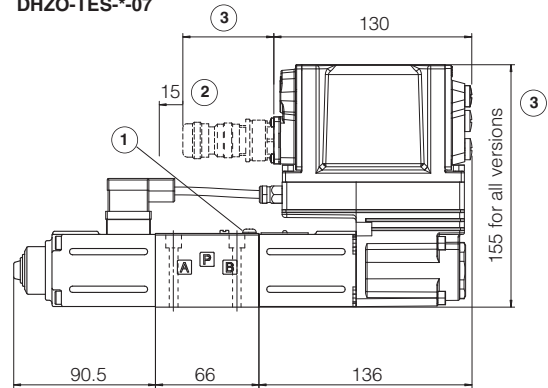

- ① = Air bleeding
- ② = Space to remove the connectors
- ③ = The dimensions of all connectors must be considered, see section 18.5 and 18.6

## DKZOR-TEB, DKZOR-TES

ISO 4401: 2000

Mounting surface: 4401-05-04-0-05 (see table P005)  
(for /Y surface 4401-05-05-0-05 without X port)

Mass [kg]	
DKZOR-*-15	4,3
DKZOR-*-17	5,0

DKZOR-TEB-\*-15  
DKZOR-TES-\*-15

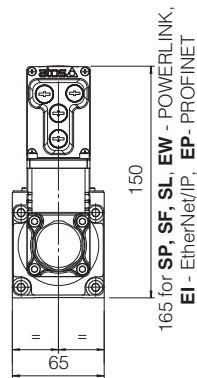
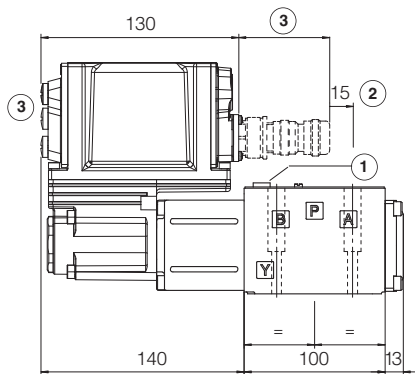

DKZOR-TEB-\*-17  
DKZOR-TES-\*-17

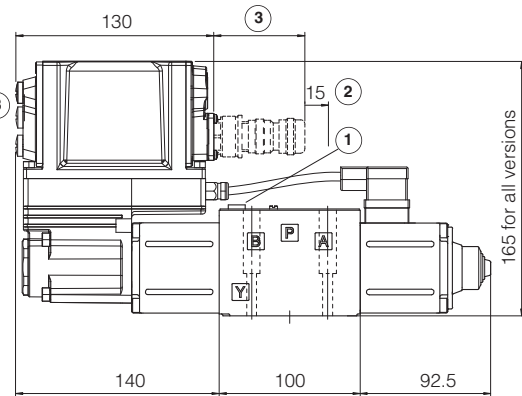

- ① = Air bleeding
- ② = Space to remove the connectors
- ③ = The dimensions of all connectors must be considered, see section 17.5 and 17.6

**Note:** for option /B the solenoid, the position transducer and the on-board digital driver are at side of port A

## 22 RELATED DOCUMENTATION

<b>F002</b>	Basics for digital electrohydraulics	<b>GS500</b>	Programming tools
<b>F003</b>	Commissioning and troubleshooting	<b>GS510</b>	Fieldbus
<b>FS230</b>	Digital proportional valves with integral axis controller	<b>K500</b>	Electric and electronic connectors
<b>FY100</b>	Safety proportional valves - option /U	<b>P005</b>	Mounting surfaces for electrohydraulic valves
<b>FY200</b>	Safety proportional valves - option /K	<b>QB300</b>	Quickstart for TEB valves commissioning
<b>GS001</b>	Basics for digital proportionals	<b>QF300</b>	Quickstart for TES valves commissioning
<b>GS002</b>	Basics for digital proportionals with P/Q control		
<b>GS003</b>	Settings for digital proportionals		