

Servoproportional directional valves

digital, direct operated, with LVDT transducer and zero spool overlap

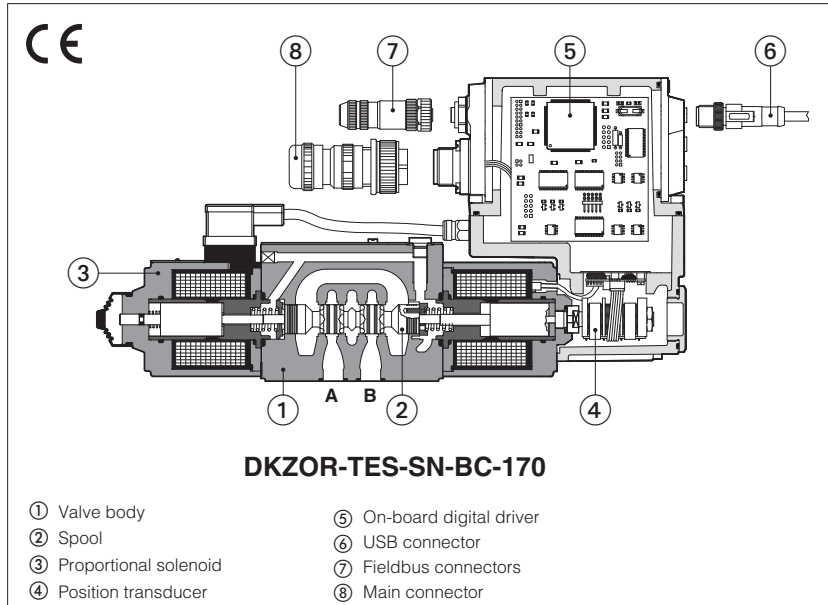

DHZO-TEB, DHZO-TEB DKZOR-TEB, DKZOR-TEB

Servoproportional direct operated digital proportional valves with LVDT position transducer and zero spool overlap for position closed loop controls. The double solenoid construction involves larger flows and central safety rest position.

TEB basic execution with analog reference signals and USB port for software functional parameters setting.

TES full execution which includes also optional alternated P/Q controls and fieldbus interfaces for functional parameters setting, reference signals and real-time diagnostics.

The on-board digital driver performs the valve's hydraulic regulation according to the reference signal and assures valve-to-valve interchangeability thanks to the factory presetting.

Digital TEZ version (see tech. table FS230) integrates on-board driver and axis card, while TEB and TES versions can be used in combination with Z-BM-KZ off-board axis card (see tech. table GS340).

DHZO:	DKZOR:
Size: 06 - ISO 4401	Size: 10 - ISO 4401
Max flow: 75 l/min	Max flow: 170 l/min
Max pressure: 350 bar	Max pressure: 315 bar

1 MODEL CODE

DHZO	-	TES	-	SN	-	NP	-	0	70	-	L	5	/	*	*	/	*		
<p>DHZO = size 06 DKZOR = size 10</p>		<p>TES = basic on-board digital driver (1) TES = full on-board digital driver</p>		<p>Alternated P/Q controls, see section 5:</p> <p>SN = none SP = pressure control (1 pressure transducer) SF = force control (2 pressure transducers) SL = force control (1 load cell)</p>		<p>Fieldbus interfaces, USB port always present:</p> <p>NP = Not present BC = CANopen BP = PROFIBUS DP EH = EtherCAT</p> <p>EW = POWERLINK EI = EtherNet/IP EP = PROFINET RT/IRT</p>		<p>Valve size ISO 4401: 0 = 06 1 = 10</p>		<p>Seals material, see section 12:</p> <p>- = NBR PE = FKM BT = HNBR</p>		<p>Series number</p>		<p>Hydraulic options (2): B = solenoid with on-board digital driver and position transducer at side of port A Y = external drain</p> <p>Electronics options (2): C = current feedback for pressure transducer 4÷20mA (omit for std voltage ±10Vdc) - only TES-SP, SF, SL F = fault signal I = current reference input and monitor 4÷20mA (omit for std voltage ±10Vdc) Q = enable signal Z = double power supply, enable, fault and monitor signals - 12 pin connector (3)</p> <p>Safety option TÜV certified - only TES (2): U = safe double power supply K = safe on/off acknowledge signals See section 7</p>		<p>Spool size: 3 (L) 5 (L,D) DHZO = 17 28 DKZOR = 45 75</p> <p>Nominal flow (l/min) at Δp 10bar P-T</p>		<p>SAFETY CERTIFIED</p>	

Configuration:

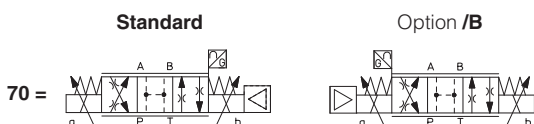

Spool type - regulating characteristics:

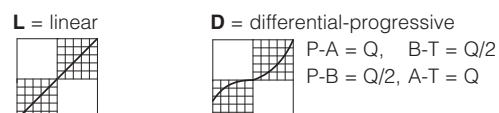

(1) Only in version SN-NP

(2) For possible combined options, see section 16

(3) Double power supply only for TES

2 GENERAL NOTES

Atos digital proportionals valves are CE marked according to the applicable directives (e.g. Immunity and Emission EMC Directive). Installation, wirings and start-up procedures must be performed according to the general prescriptions shown in tech table **F003** and in the user manuals included in the E-SW-* programming software.

3 VALVE SETTINGS AND PROGRAMMING TOOLS

Valve's functional parameters and configurations, can be easily set and optimized using Atos E-SW programming software connected via USB port to the digital driver (see table **GS003**). For fieldbus versions, the software permits valve's parameterization through USB port also if the driver is connected to the central machine unit via fieldbus.

The software is available in different versions according to the driver's options (see table **GS500**):

E-SW-BASIC	support: NP (USB)	PS (Serial)	IR (Infrared)
E-SW-FIELDBUS	support: BC (CANopen)	BP (PROFIBUS DP)	EH (EtherCAT)
	EW (POWERLINK)	EI (EtherNet/IP)	EP (PROFINET)
E-SW-*/PQ	support: valves with SP, SF, SL alternated control (e.g. E-SW-BASIC/PQ)		

WARNING: drivers USB port is not isolated! For E-C-SB-USB/M12 cable, the use of isolator adapter is highly recommended for PC protection

WARNING: Bluetooth adapter is available only for European, USA and Canadian markets! Bluetooth adapter is certified according RED (Europe), FCC (USA) and ISED (Canada) directives

USB or Bluetooth connection

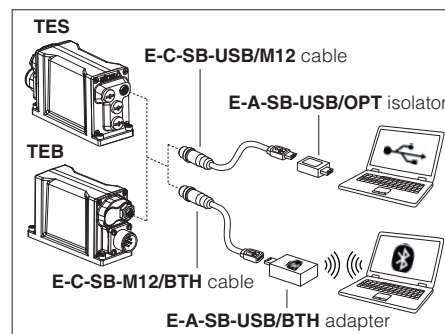

4 FIELDBUS - only for TES, see tech. table GS510

Fieldbus allows valve direct communication with machine control unit for digital reference, valve diagnostics and settings. These execution allow to operate the valves through fieldbus or analog signals available on the main connector.

5 ALTERNATED P/Q CONTROLS - only for TES, see tech. table GS002

S* options add the closed loop control of pressure (**SP**) or force (**SF** and **SL**) to the basic functions of proportional directional valves flow regulation. A dedicated algorithm alternates pressure (force) depending on the actual hydraulic system conditions.

An additional connector is available for transducers to be interfaced to the valve's driver (1 pressure transducer for SP, 2 pressure transducers for SF or 1 load cell for SL). The alternated pressure control (SP) is possible only for specific installation conditions.

Main 12 pin connector is the same as /Z option plus two analog signals specific for the pressure (force) control.

6 AXIS CONTROLLER - see tech. table FS230

Digital servoproportional with integral electronics **TEZ** include valve's driver plus axis controller, performing position closed loop of any hydraulic actuator equipped with analog, encoder or SSI position transducer. **S*** option add alternated P/Q control to the basic position ones.

Atos also supplies complete servoactuators integrating servocylinder, digital servoproportional valve and axis controller, fully assembled and tested. For more information consult Atos Technical Office.

7 SAFETY OPTIONS - only for TES

Atos range of proportional directional valves, provides functional safety options **/U** and **/K**, designed to accomplish a safety function, intended to reduce the risk in process control systems. They are **TÜV certified** in compliance to **IEC 61508 up to SIL 3** and **ISO 13849 up to category 4, PL e**



Safe double power supply, option **/U**: the driver has separate power supplies for logic and solenoids. The safe condition is reached by cutting the electrical supply to solenoids, while electronics remains active for monitoring functions and fieldbus communication, see tech table **FY100**

Safety function via on/off signals, option **/K**: upon a disable command, the driver checks the spool position and it provides an acknowledgement signal only when the valve is in safe condition, see tech table **FY200**

8 CENTRAL SAFETY REST POSITION OF ZERO SPOOL OVERLAP - configuration 70

In absence of electric power supply (+24 VDC), the valve main spool is moved by the springs force to the **central safety rest position** characterized by a small offset of about 1% to 6% of the total stroke in P-B / A-T configuration.

This is specifically designed to avoid that in case of accidental interruption of the electrical power supply to the valve, the actuator moves towards an undefined direction (due to the tolerances of the zero overlap spool), with potential risk of damages or personnel injury.

Thanks to the **central safety rest position** the actuator movement is suddenly stopped and it is recovered at very low speed towards the direction corresponding to the P-B/ A-T connection.

The main spool moves to the closed loop control position (zero overlap) when the pilot pressure is activated, the valve is fed with power supply +24 VDC and reference input = 0V (or 12 mA for option /I) is applied to the driver.

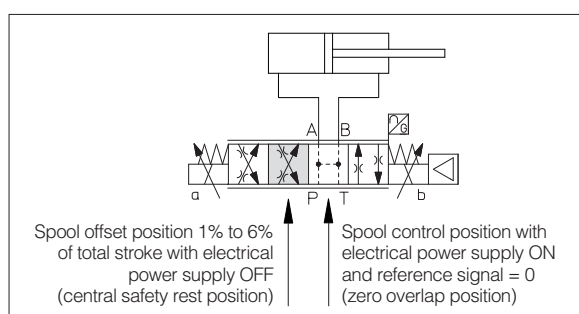

9 GENERAL CHARACTERISTICS

Assembly position	Any position
Subplate surface finishing to ISO 4401	Acceptable roughness index: Ra ≤ 0,8, recommended Ra 0,4 – Flatness ratio 0,01/100
MTTFd valves according to EN ISO 13849	150 years, see technical table P007
Ambient temperature range	Standard = -20°C ÷ +60°C /PE option = -20°C ÷ +60°C /BT option = -40°C ÷ +60°C
Storage temperature range	Standard = -20°C ÷ +70°C /PE option = -20°C ÷ +70°C /BT option = -40°C ÷ +70°C
Surface protection	Zinc coating with black passivation (body) galvanic treatment (driver housing)
Corrosion resistance	Salt spray test (EN ISO 9227) > 200 h
Conformity	RoHs Directive 2011/65/EU as last update by 2015/65/EU REACH Regulation (EC) n°1907/2006

10 HYDRAULIC CHARACTERISTICS - based on mineral oil ISO VG 46 at 50 °C

Valve model	DHZO			DKZOR		
Pressure limits [bar]	ports P, A, B = 350; T = 210 (250 with external drain /Y) Y = 10			ports P, A, B = 315; T = 210 (250 with external drain /Y) Y = 10		
Spool Type	L3	L5	D5	L3	L5	D5
Nominal flow (1)						
[l/min] $\Delta p = 10$ bar	18	28	28	45	75	75
$\Delta p = 30$ bar	30	50	50	80	130	130
$\Delta p = 70$ bar	45	75	75	120	170	170
Max flow (2)	50	80	80	130	180	180
Leakage [cm ³ /min]	<500 (at p = 100 bar); <1500 (at p = 350 bar)			<800 (at p = 100 bar); <2500 (at p = 315 bar)		
Response time (3) [ms]	≤ 15			≤ 20		
Hysteresis	≤ 0,2 [% of max regulation]					
Repeatability	± 0,1 [% of max regulation]					
Thermal drift	zero point displacement < 1% at $\Delta T = 40^{\circ}C$					

(1) For different Δp , the max flow is in accordance to the diagrams in section 13.2

(2) See detailed diagrams in section 13.3

(3) 0-100% step signal

11 ELECTRICAL CHARACTERISTICS

Power supplies	Nominal : +24 VDC Rectified and filtered : $V_{RMS} = 20 \div 32 V_{MAX}$ (ripple max 10 % VPP)			
Max power consumption	50 W			
Max. solenoid current	DHZO = 2,6 A		DKZOR = 3 A	
Coil resistance R at 20°C	DHZO = 3 \div 3,3 Ω		DKZOR = 3,8 \div 4,1 Ω	
Analog input signals	Voltage: range ± 10 VDC (24 V_{MAX} tollerant) Current: range ± 20 mA		Input impedance: $R_i > 50$ k Ω Input impedance: $R_i = 500$ Ω	
Monitor outputs	Output range: voltage ± 10 VDC @ max 5 mA current ± 20 mA @ max 500 Ω load resistance			
Enable input	Range: 0 \div 5 VDC (OFF state), 9 \div 24 VDC (ON state), 5 \div 9 VDC (not accepted); Input impedance: $R_i > 10$ k Ω			
Fault output	Output range: 0 \div 24 Vdc (ON state > [power supply - 2 V] ; OFF state < 1 V) @ max 50 mA; external negative voltage not allowed (e.g. due to inductive loads)			
Pressure/Force transducer power supply (only for SP, SF, SL)	+24Vdc @ max 100 mA (E-ATR-8 see tech table GS465)			
Alarms	Solenoid not connected/short circuit, cable break with current reference signal, over/under temperature, valve spool transducer malfunctions, alarms history storage function			
Insulation class	H (180°) Due to the occurring surface temperatures of the solenoid coils, the European standards ISO 13732-1 and EN982 must be taken into account			
Protection degree to DIN EN60529	IP66 / IP67 with mating connectors			
Duty factor	Continuous rating (ED=100%)			
Tropicalization	Tropical coating on electronics PCB			
Additional characteristics	Short circuit protection of solenoid's current supply; 3 leds for diagnostic; spool position control (SN) or pressure/force control (SP, SF, SL) by P.I.D. with rapid solenoid switching; protection against reverse polarity of power supply			
Electromagnetic compatibility (EMC)	According to Directive 2014/30/UE (Immunity: EN 61000-6-2; Emission: EN 61000-6-3)			
Communication interface	USB Atos ASCII coding	CANopen EN50325-4 + DS408	PROFIBUS DP EN50170-2/IEC61158	EtherCAT, POWERLINK, EtherNet/IP, PROFINET IO RT / IRT EC 61158
Communication physical layer	not insulated USB 2.0 + USB OTG	optical insulated CAN ISO11898	optical insulated RS485	Fast Ethernet, insulated 100 Base TX
Recommended wiring cable	LiYCY shielded cables, see section 20			

Note: a maximum time of 800 ms (depending on communication type) have be considered between the driver energizing with the 24 Vdc power supply and when the valve is ready to operate. During this time the current to the valve coils is switched to zero.

12 SEALS AND HYDRAULIC FLUIDS - for other fluids not included in below table, consult our technical office

Seals, recommended fluid temperature	NBR seals (standard) = -20°C \div +60°C, with HFC hydraulic fluids = -20°C \div +50°C FKM seals (/PE option) = -20°C \div +80°C HNBR seals (/BT option) = -40°C \div +60°C, with HFC hydraulic fluids = -40°C \div +50°C		
Recommended viscosity	20 \div 100 mm ² /s - max allowed range 15 \div 380 mm ² /s		
Max fluid contamination level	normal operation	ISO4406 class 18/16/13 NAS1638 class 7	see also filter section at
	longer life	ISO4406 class 16/14/11 NAS1638 class 5	www.atos.com or KTF catalog
Hydraulic fluid	Suitable seals type	Classification	Ref. Standard
Mineral oils	NBR, FKM, HNBR	HL, HLP, HLPD, HVLP, HVLPD	DIN 51524
Flame resistant without water	FKM	HFDU, HFDR	ISO 12922
Flame resistant with water	NBR, HNBR	HFC	

13 DIAGRAMS - based on mineral oil ISO VG 46 at 50 °C

13.1 Regulation diagrams (values measure at Δp 30 bar P-T)

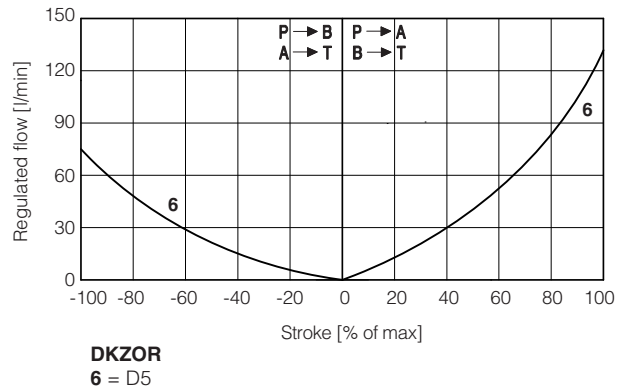
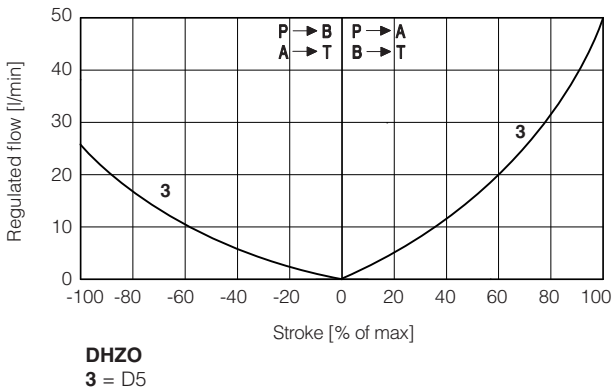
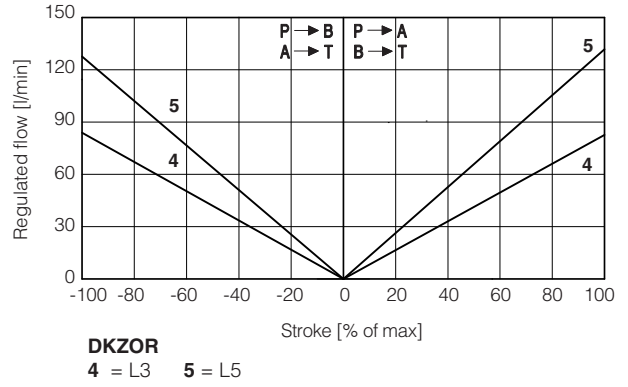
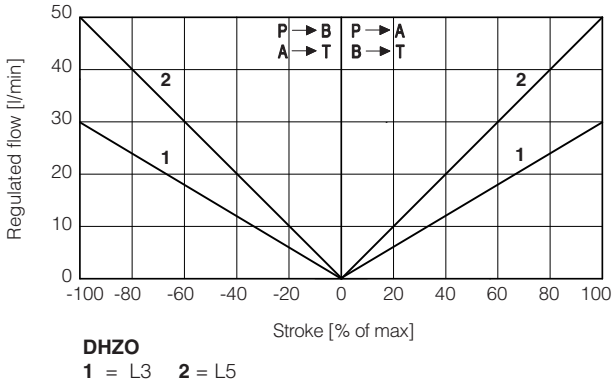

Note:

Hydraulic configuration vs. reference signal for configurations 70 (standard and option /B)

Reference signal $\left. \begin{matrix} 0 \div +10 \text{ V} \\ 12 \div 20 \text{ mA} \end{matrix} \right\} P \rightarrow A / B \rightarrow T$ Reference signal $\left. \begin{matrix} 0 \div -10 \text{ V} \\ 12 \div 4 \text{ mA} \end{matrix} \right\} P \rightarrow B / A \rightarrow T$

13.2 Flow / Δp diagrams

stated at 100% of valve stroke

DHZO
1 = spool L3,
2 = spool L5, D5

DKZOR
3 = spool L3
4 = spool L5, D5

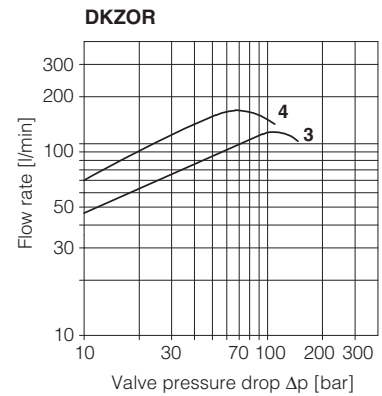
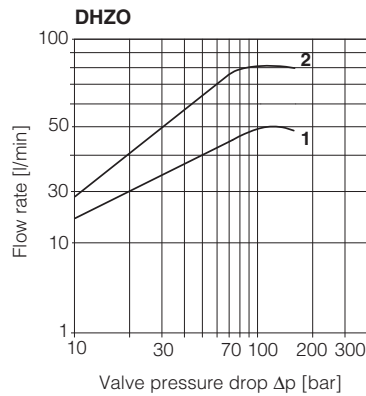

13.3 Operating limits

DHZO
1 = spool L3
2 = spool L5, D5

DKZOR
3 = spool L3
4 = spool L5, D5

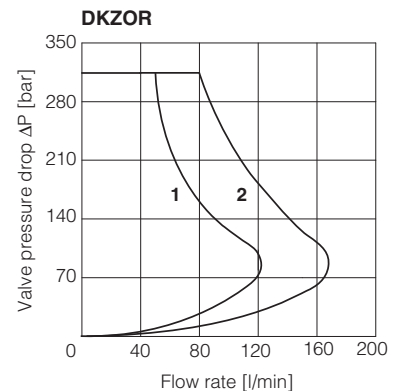
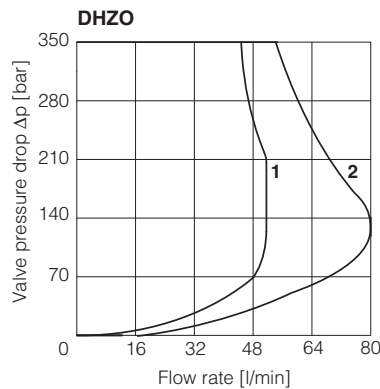

13.4 Response time

The response times in below diagrams are measured at different steps of the reference input signal. They have to be considered as average values. For the valves with digital electronics the dynamics performances can be optimized by setting the internal software parameters.

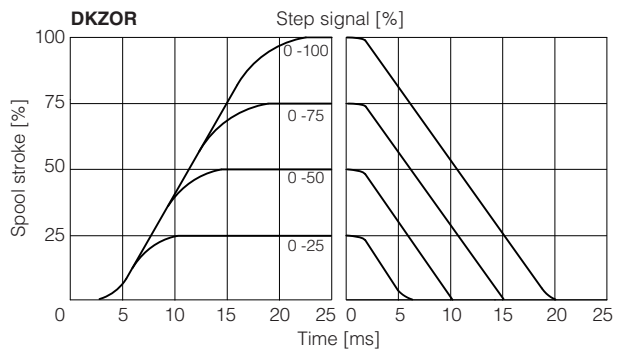
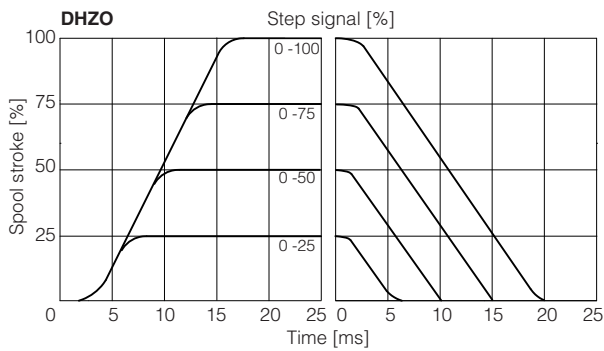

13.5 Bode diagrams

- 1 = 10% ↔ 90% nominal stroke
- 2 = 50% ± 5% nominal stroke

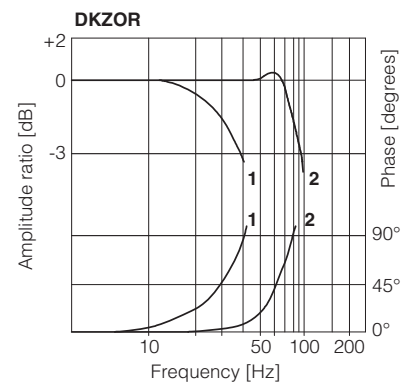
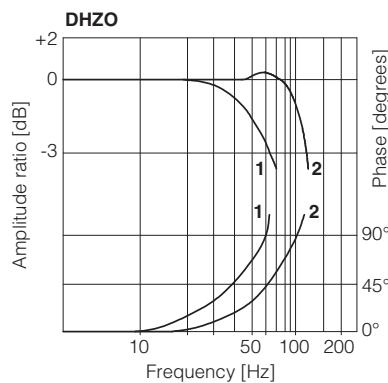

14 HYDRAULIC OPTIONS

- B** = Solenoid, on-board digital driver and position transducer at side of port A of the main stage. For hydraulic configuration vs reference signal, see 13.1
- Y** = This option is mandatory if the pressure in port T exceeds 210 bar.

15 ELECTRONICS OPTIONS

- F** = This option permits to monitor the eventual fault condition of the driver, as for example the solenoid short circuit/not connected, reference signal cable broken for option /I, spool position transducer broken, etc. - see 17.9 for signal specifications.
- I** = This option provides 4 ÷ 20 mA current reference and monitor signals, instead of the standard ±10 Vdc. Input signal can be reconfigured via software selecting between voltage and current, within a maximum range of ±10 Vdc or ±20 mA. It is normally used in case of long distance between the machine control unit and the valve or where the reference signal can be affected by electrical noise; the valve functioning is disabled in case of reference signal cable breakage.
- Q** = This option permits to inhibit the valve function without removing the power supply to the driver. Upon disable command the current to the solenoid is zeroed and the valve's spool moves to rest position. The option /Q is suggested for all cases where the valve has to be frequently inhibited during the machine cycle – see 17.7 for signal specifications.
- Z** = This option provides, on the 12 pin main connector, the following additional features:
 - Fault output signal** - see above option /F
 - Enable input signal** - see above option /Q
 - Repeat enable output signal** - only for **TEB** (see 17.8)
 - Power supply for driver's logics and communication** - only for **TES** (see 17.2)
- C** = This option is available to connect pressure (force) transducers with 4 ÷ 20 mA current output signal, instead of the standard ±10 Vdc. Input signal can be reconfigured via software selecting between voltage and current, within a maximum range of ±10 Vdc or ±20 mA.

16 POSSIBLE COMBINED OPTIONS

Standard versions for **TEB-SN** and **TES-SN**:

/BF, /BFI, /BFIY, /BFY, /BI, /BIQ, /BIQY, /BIY, /BIYZ, /BIZ, /BQ, /BQY, /BY, /BYZ, /BZ, /FI, /FIY, /FY, /IQ, /IQY, /IY, /IYZ, /IZ, /QY, /YZ

Standard versions for **TES-SP, SF, SL**:

/BC, /BCI, /BCIY, /BCY, /BI, /BIY, /BY, /CI, /CIY, /CY, /IY

Safety certified versions for **TES-SN**:

/BIU, /BIUY, /BU, /BUY, /IU, /IUY, /UY, /BIK, /BIKY, /BK, /BKY, /IK, /IKY, /KY

Safety certified versions for **TES-SP, SF, SL**:

/BCU, /BCIU, /BCIUY, /BCUY, /BIU, /BIUY, /BU, /BUY, /CU, /CIU, /CIUY, /CUY, /IU, /IUY, /UY, /BCK, /BCKI, /BCKIY, /BCKY, /BIK, /BIKY, /BK, /BKY, /CK, /CKI, /CKIY, /CKY, /IK, /IKY, /KY

17 POWER SUPPLY AND SIGNALS SPECIFICATIONS

Generic electrical output signals of the valve (e.g. fault or monitor signals) must not be directly used to activate safety functions, like to switch-ON/OFF the machine's safety components, as prescribed by the European standards (Safety requirements of fluid technology systems and components-hydraulics, EN-982).

For certified safety options: /U see tech. table **FY100** and /K see tech. table **FY200**

17.1 Power supply (V+ and V0)

The power supply must be appropriately stabilized or rectified and filtered: apply at least a 10000 μ F/40 V capacitance to single phase rectifiers or a 4700 μ F/40 V capacitance to three phase rectifiers. In case of separate power supply see 17.2.



A safety fuse is required in series to each power supply: 2,5 A time lag fuse.

17.2 Power supply for driver's logic and communication (VL+ and VL0) - only for /Z option and TES-SP, SF, SL with fieldbus

The power supply for driver's logic and communication must be appropriately stabilized or rectified and filtered: apply at least a 10000 μ F/40 V capacitance to single phase rectifiers or a 4700 μ F/40 V capacitance to three phase rectifiers.

The separate power supply for driver's logic on pin 9 and 10, allow to remove solenoid power supply from pin 1 and 2 maintaining active the diagnostics, USB and fieldbus communications.



A safety fuse is required in series to each driver's logic and communication power supply: 500 mA fast fuse.

17.3 Flow reference input signal (Q_INPUT+)

The driver controls in closed loop the valve spool position proportionally to the external reference input signal.

Reference input signal is factory preset according to selected valve code, defaults are ± 10 VDC for standard and $4 \div 20$ mA for /I option.

Input signal can be reconfigured via software selecting between voltage and current, within a maximum range of ± 10 VDC or ± 20 mA.

Drivers with fieldbus interface can be software set to receive reference signal directly from the machine control unit (fieldbus reference).

Analog reference input signal can be used as on-off commands with input range $0 \div 24$ VDC.

17.4 Pressure or force reference input signal (F_INPUT+) - only for TES-SP, SF, SL

Functionality of F_INPUT+ signal (pin 7), is used as reference for the driver pressure/force closed loop (see tech. table **GS002**).

Reference input signal is factory preset according to selected valve code, defaults are ± 10 VDC for standard and $4 \div 20$ mA for /I option.

Input signal can be reconfigured via software selecting between voltage and current, within a maximum range of ± 10 VDC or ± 20 mA.

Drivers with fieldbus interface can be software set to receive reference signal directly by the machine control unit (fieldbus reference).

Analog reference input signal can be used as on-off commands with input range $0 \div 24$ VDC.

17.5 Flow monitor output signal (Q_MONITOR) - not for /F

The driver generates an analog output signal proportional to the actual spool position of the valve; the monitor output signal can be software set to show other signals available in the driver (e.g. analog reference, fieldbus reference, pilot spool position).

Monitor output signal is factory preset according to selected valve code, defaults are ± 10 VDC for standard and $4 \div 20$ mA for /I option.

Output signal can be reconfigured via software selecting between voltage and current, within a maximum range of ± 10 VDC or ± 20 mA.

17.6 Pressure or force monitor output signal (F_MONITOR) - only for TES-SP, SF, SL

The driver generates an analog output signal proportional to alternated pressure/force control; the monitor output signal can be software set to show other signals available in the driver (e.g. analog reference, force reference).

Monitor output signal is factory preset according to selected valve code, defaults are ± 10 VDC for standard and $4 \div 20$ mA for /I option.

Output signal can be reconfigured via software selecting between voltage and current, within a maximum range of ± 10 VDC or ± 20 mA.

17.7 Enable input signal (ENABLE) - not for standard and /F

To enable the driver, supply a 24 VDC on pin 3 (pin C): Enable input signal allows to enable/disable the current supply to the solenoid, without removing the electrical power supply to the driver; it is used to active the communication and the other driver functions when the valve must be disabled for safety reasons. This condition **does not comply** with norms IEC 61508 and ISO 13849.

Enable input signal can be used as generic digital input by software selection.

17.8 Repeat enable output signal (R_ENABLE) - only for TEB with /Z option

Repeat enable is used as output repeater signal of enable input signal (see 17.7).

17.9 Fault output signal (FAULT) - not for standard and /Q

Fault output signal indicates fault conditions of the driver (solenoid short circuits/not connected, reference signal cable broken for $4 \div 20$ mA input, spool position transducer cable broken, etc.). Fault presence corresponds to 0 VDC, normal working corresponds to 24 VDC.

Fault status is not affected by the Enable input signal. Fault output signal can be used as digital output by software selection.

17.10 Remote pressure/force transducer input signal - only for TES-SP, SF, SL

Analog remote pressure transducers or load cell can be directly connected to the driver (see 18.4).

Analog input signal is factory preset according to selected valve code, defaults are ± 10 VDC for standard and $4 \div 20$ mA for /C option.

Input signal can be reconfigured via software selecting between voltage and current, within a maximum range of ± 10 VDC or ± 20 mA.

Refer to pressure/force transducer characteristics to select the transducer type according to specific application requirements (see tech table **GS002**).

17.11 Multiple PID selection (D_IN0 and D_IN1) - only NP execution for TES-SP, SF, SL

Two on-off input signals are available on the main connector to select one of the four pressure (force) PID parameters setting, stored into the driver.

Switching the active setting of pressure PID during the machine cycle allows to optimize the system dynamic response in different hydraulic working conditions (volume, flow, etc.).

Supply a 24 Vdc or a 0 VDC on pin 9 and/or pin 10, to select one of the PID settings as indicated by binary code table at side. Gray code can be selected by software.

PIN	PID SET SELECTION			
	SET 1	SET 2	SET 3	SET 4
9	0	24 Vdc	0	24 Vdc
10	0	0	24 Vdc	24 Vdc

18 ELECTRONIC CONNECTIONS

18.1 Main connector signals - 7 pin (A1) Standard, /Q and /F options

PIN	Standard	/Q	/F	TECHNICAL SPECIFICATIONS	NOTES
A	V+			Power supply 24 Vdc	Input - power supply
B	V0			Power supply 0 Vdc	Gnd - power supply
C	AGND		AGND	Analog ground	Gnd - analog signal
		ENABLE		Enable (24 Vdc) or disable (0 Vdc) the valve, referred to V0	Input - on/off signal
D	Q_INPUT+			Flow reference input signal: ± 10 Vdc / ± 20 mA maximum range Defaults are ± 10 Vdc for standard and $4 \div 20$ mA for /I option	Input - analog signal Software selectable
E	INPUT-			Negative reference input signal for Q_INPUT+	Input - analog signal
F	Q_MONITOR referred to: AGND V0			Flow monitor output signal: ± 10 Vdc / ± 20 mA maximum range Defaults are ± 10 Vdc for standard and $4 \div 20$ mA for /I option	Output - analog signal Software selectable
			FAULT	Fault (0 Vdc) or normal working (24 Vdc)	Output - on/off signal
G	EARTH			Internally connected to the driver housing	

18.2 Main connector signals - 12 pin (A2) /Z option and TES-SP, SF, SL

PIN	TEB-SN /Z	TES-SN /Z	TES-SP, SF, SL Fieldbus	NP	TECHNICAL SPECIFICATIONS	NOTES
1	V+				Power supply 24 Vdc	Input - power supply
2	V0				Power supply 0 Vdc	Gnd - power supply
3	ENABLE referred to: V0 VL0 VL0 V0				Enable (24 Vdc) or disable (0 Vdc) the valve	Input - on/off signal
4	Q_INPUT+				Flow reference input signal: ± 10 Vdc / ± 20 mA maximum range Defaults are ± 10 Vdc for standard and $4 \div 20$ mA for /I option	Input - analog signal Software selectable
5	INPUT-				Negative reference input signal for Q_INPUT+ and F_INPUT+	Input - analog signal
6	Q_MONITOR referred to: AGND VL0 VL0 V0				Flow monitor output signal: ± 10 Vdc / ± 20 mA maximum range Defaults are ± 10 Vdc for standard and $4 \div 20$ mA for /I option	Output - analog signal Software selectable
7	AGND				Analog ground	Gnd - analog signal
		NC			Do not connect	
8	R_ENABLE				Repeat enable, output repeter signal of enable input, referred to V0	Output - on/off signal
		NC			Do not connect	
9	NC				Do not connect	
		VL+			Power supply 24 Vdc for driver's logic and communication	Input - power supply
10	NC				Do not connect	
		VL0			Power supply 0 Vdc for driver's logic and communication	Gnd - power supply
11	FAULT referred to: V0 VL0 VL0 V0				Fault (0 Vdc) or normal working (24 Vdc)	Output - on/off signal
	PE				Internally connected to the driver housing	

Note: do not disconnect VL0 before VL+ when the driver is connected to PC USB port

18.3 Communications connectors (B) - (C)

(B) USB connector - M12 - 5 pin always present		
PIN	SIGNAL	TECHNICAL SPECIFICATION (1)
1	+5V_USB	Power supply
2	ID	Identification
3	GND_USB	Signal zero data line
4	D-	Data line -
5	D+	Data line +

(C1) (C2) BC fieldbus execution, connector - M12 - 5 pin		
PIN	SIGNAL	TECHNICAL SPECIFICATION (1)
1	CAN_SHLD	Shield
2	not used	(C1) - (C2) pass-through connection (2)
3	CAN_GND	Signal zero data line
4	CAN_H	Bus line (high)
5	CAN_L	Bus line (low)

(C1) (C2) BP fieldbus execution, connector - M12 - 5 pin		
PIN	SIGNAL	TECHNICAL SPECIFICATION (1)
1	+5V	Termination supply signal
2	LINE-A	Bus line (high)
3	DGND	Data line and termination signal zero
4	LINE-B	Bus line (low)
5	SHIELD	

(C1) (C2) EH, EW, EI, EP fieldbus execution, connector - M12 - 4 pin		
PIN	SIGNAL	TECHNICAL SPECIFICATION (1)
1	TX+	Transmitter
2	RX+	Receiver
3	TX-	Transmitter
4	RX-	Receiver
Housing	SHIELD	

(1) Shield connection on connector's housing is recommended

(2) Pin 2 can be fed with external +5V supply of CAN interface

18.4 Remote pressure/force transducer connector - M12 - 5 pin - only for SP, SF, SL (D)

PIN	SIGNAL	TECHNICAL SPECIFICATION	NOTES	(D1) SP, SL - Single transducer (1)		(D2) SF - Double transducers (1)	
				Voltage	Current	Voltage	Current
1	VF +24V	Power supply +24Vdc	Output - power supply	Connect	Connect	Connect	Connect
2	TR1	1st signal transducer: ±10 V _{dc} / ±20 mA maximum range	Input - analog signal Software selectable	Connect	Connect	Connect	Connect
3	AGND	Common gnd for transducer power and signals	Common gnd	Connect	/	Connect	/
4	TR2	2nd signal transducer: ±10 V _{dc} / ±20 mA maximum range	Input - analog signal Software selectable	/	/	Connect	Connect
5	NC	Not connect		/	/	/	/

(1) Single/double transducer configuration is software selectable

Remote pressure transducers connection - example

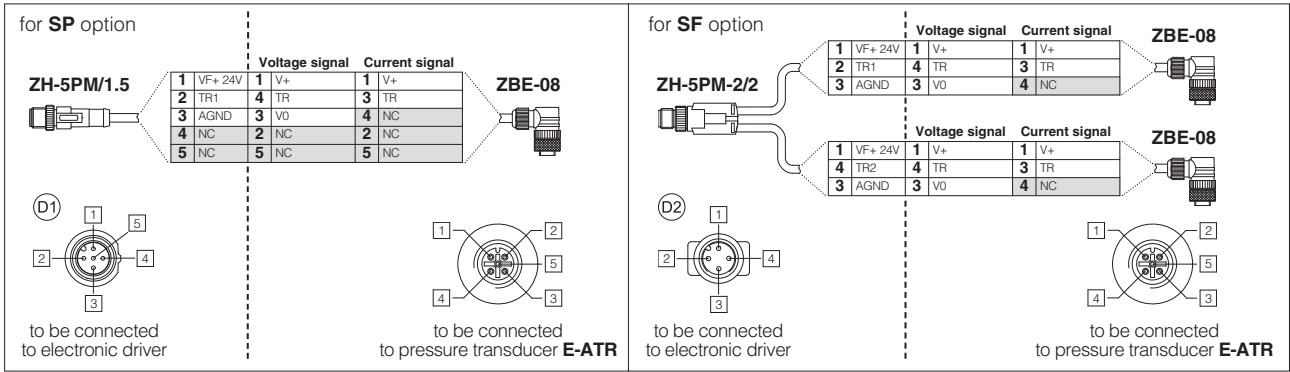

Note: pin layout always referred to driver's view

18.5 TEB connections layout

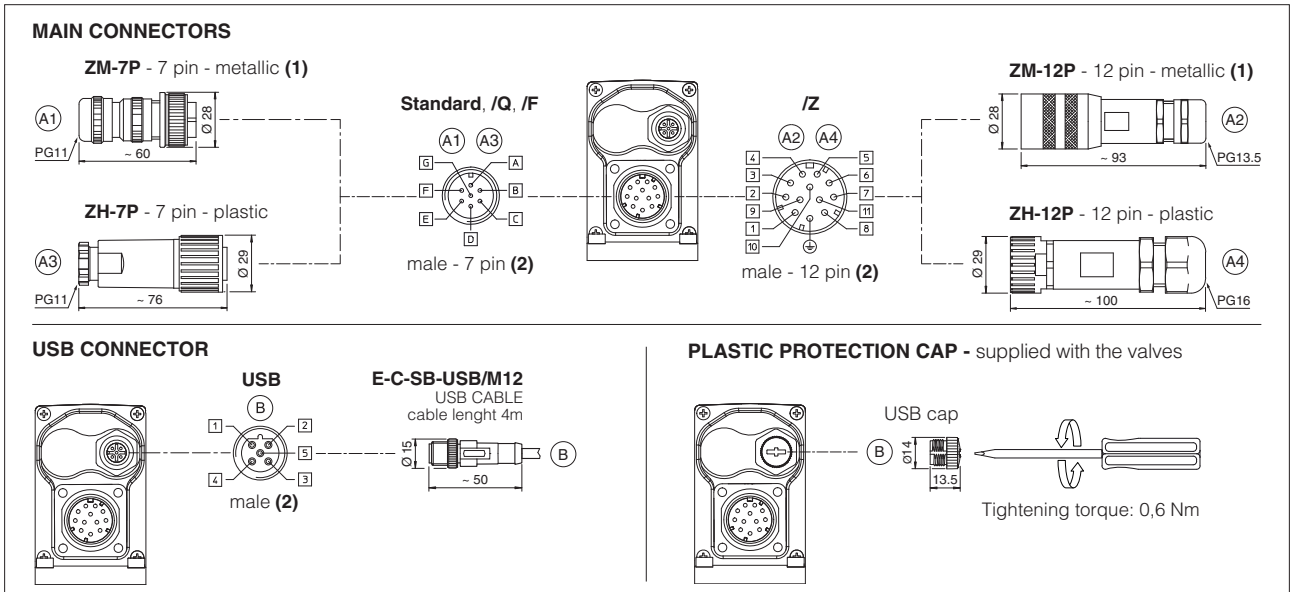

(1) Use of metallic connectors is strongly recommended in order to fulfill EMC requirements (2) Pin layout always referred to driver's view

18.6 TES connections layout

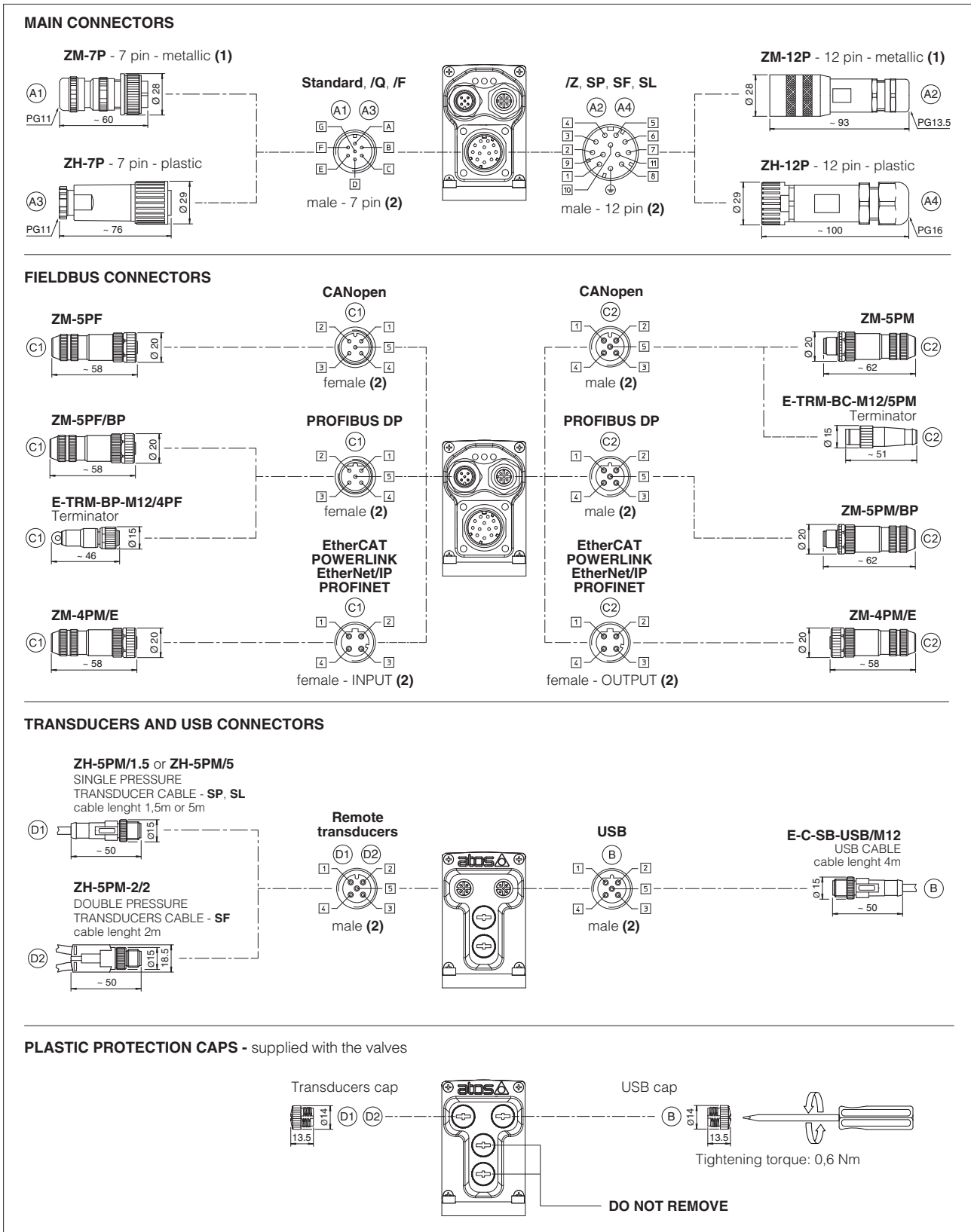

(1) Use of metallic connectors is strongly recommended in order to fulfill EMC requirements (2) Pin layout always referred to driver's view

18.7 Diagnostic LEDs - only for TES

Three leds show driver operative conditions for immediate basic diagnostics. Please refer to the driver user manual for detailed information.

FIELDBUS LEDS	NP Not Present	BC CANopen	BP PROFIBUS DP	EH EtherCAT	EW POWERLINK	EI EtherNet/IP	EP PROFINET	L1 L2 L3
L1		VALVE STATUS			LINK/ACT			
L2		NETWORK STATUS			NETWORK STATUS			
L3		SOLENOID STATUS			LINK/ACT			

19 IN / OUT FIELDBUS COMMUNICATION CONNECTORS

Two fieldbus communication connectors are always available for digital drivers executions BC, BP, EH, EW, EI, EP. This features allows considerable technical advantages in terms of installation simplicity, wirings reduction and also avoid the usage expensive T-connectors.

For BC and BP executions the fieldbus connectors have an internal pass-through connection and can be used like end point of the fieldbus network, using an external terminator (see tech table **GS500**).

For EH, EW, EI and EP executions the external terminators are not required: each connector is internally terminated.

BC and BP pass-through connection

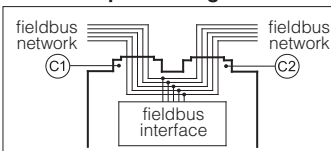

20 CONNECTORS CHARACTERISTICS - to be ordered separately

20.1 Main connectors - 7 pin

CONNECTOR TYPE	POWER SUPPLY	POWER SUPPLY
CODE	(A1) ZM-7P	(A3) ZH-7P
Type	7pin female straight circular	7pin female straight circular
Standard	According to MIL-C-5015	According to MIL-C-5015
Material	Metallic	Plastic reinforced with fiber glass
Cable gland	PG11	PG11
Recommended cable	LiYCY 7 x 0,75 mm ² max 20 m (logic and power supply) or LiYCY 7 x 1 mm ² max 40 m (logic and power supply)	LiYCY 7 x 0,75 mm ² max 20 m (logic and power supply) or LiYCY 7 x 1 mm ² max 40 m (logic and power supply)
Conductor size	up to 1 mm ² - available for 7 wires	up to 1 mm ² - available for 7 wires
Connection type	to solder	to solder
Protection (EN 60529)	IP 67	IP 67

20.2 Main connectors - 12 pin

CONNECTOR TYPE	POWER SUPPLY	POWER SUPPLY
CODE	(A2) ZM-12P	(A4) ZH-12P
Type	12pin female straight circular	12pin female straight circular
Standard	DIN 43651	DIN 43651
Material	Metallic	Plastic reinforced with fiber glass
Cable gland	PG13,5	PG16
Recommended cable	LiYCY 12 x 0,75 mm ² max 20 m (logic and power supply)	LiYCY 10 x 0,14mm ² max 40 m (logic) LiYY 3 x 1mm ² max 40 m (power supply)
Conductor size	0,5 mm ² to 1,5 mm ² - available for 12 wires	0,14 mm ² to 0,5 mm ² - available for 9 wires 0,5 mm ² to 1,5 mm ² - available for 3 wires
Connection type	to crimp	to crimp
Protection (EN 60529)	IP 67	IP 67

20.3 Fieldbus communication connectors

CONNECTOR TYPE	BC CANopen (1)		BP PROFIBUS DP (1)		EH EtherCAT, EW POWERLINK, EI EtherNet/IP, EP PROFINET (2)	
CODE	(C1) ZM-5PF	(C2) ZM-5PM	(C1) ZM-5PF/BP	(C2) ZM-5PM/BP	(C1) (C2) ZM-4PM/E	
Type	5 pin female straight circular	5 pin male straight circular	5 pin female straight circular	5 pin male straight circular	4 pin male straight circular	
Standard	M12 coding A – IEC 61076-2-101		M12 coding B – IEC 61076-2-101		M12 coding D – IEC 61076-2-101	
Material	Metallic		Metallic		Metallic	
Cable gland	Pressure nut - cable diameter 6÷8 mm		Pressure nut - cable diameter 6÷8 mm		Pressure nut - cable diameter 4÷8 mm	
Cable	CANbus Standard (DR 303-1)		PROFIBUS DP Standard		Ethernet standard CAT-5	
Connection type	screw terminal		screw terminal		terminal block	
Protection (EN 60529)	IP67		IP 67		IP 67	



(1) E-TRM-** terminators can be ordered separately - see tech table **GS500**

(2) Internally terminated

20.4 Pressure/Force transducer connectors - only for SP, SF, SL

CONNECTOR TYPE	SP, SL - Single transducer		SF - Double transducers
CODE	(D1) ZH-5PM/1.5	(D1) ZH-5PM/5	(D2) ZH-5PM-2/2
Type	5 pin male straight circular		4 pin male straight circular
Standard	M12 coding A – IEC 61076-2-101		M12 coding A – IEC 61076-2-101
Material	Plastic		Plastic
Cable gland	Connector moulded on cables 1,5 m lenght 5 m lenght		Connector moulded on cables 2 m lenght
Cable	5 x 0,25 mm ²		3 x 0,25 mm ² (both cables)
Connection type	molded cable		splitting cable
Protection (EN 60529)	IP 67		IP 67

21 FASTENING BOLTS AND SEALS

	DHZO	DKZOR
	Fastening bolts: 4 socket head screws M5x50 class 12.9 Tightening torque = 8 Nm	Fastening bolts: 4 socket head screws M6x40 class 12.9 Tightening torque = 15 Nm
	Seals: 4 OR 108; Diameter of ports A, B, P, T: Ø 7,5 mm (max) 1 OR 2025 Diameter of port Y: Ø = 3,2 mm (only for /Y option)	Seals: 5 OR 2050; Diameter of ports A, B, P, T: Ø 11,2 mm (max) 1 OR 108 Diameter of port Y: Ø = 5 mm (only for /Y option)

DHZO-TEB, DHZO-TES

ISO 4401: 2000
 Mounting surface: 4401-03-02-0-05 (see table P005)
 (for /Y surface 4401-03-03-0-05 without X port)

Mass [kg]	
DHZO	3,1

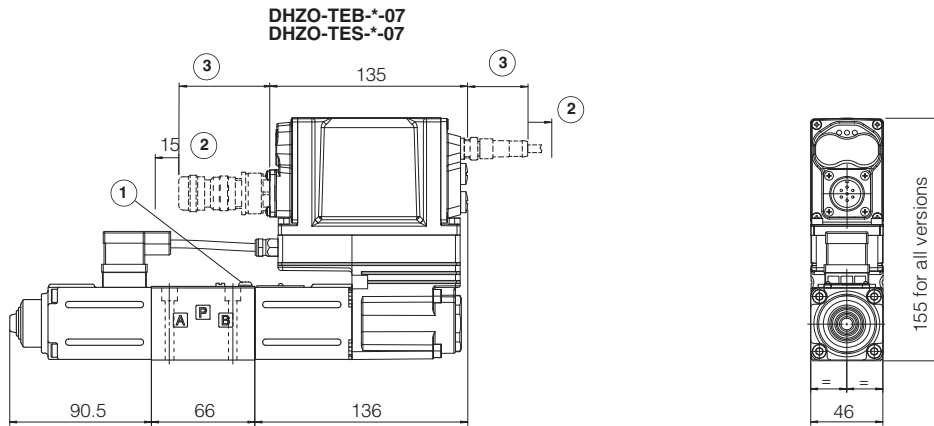

- ① = Air bleeding 3
- ② = Space to remove the connectors
- ③ = The dimensions of all connectors must be considered, see section 18.5 and 18.6

DKZOR-TEB, DKZOR-TES

ISO 4401: 2000
 Mounting surface: 4401-05-04-0-05 (see table P005)
 (for /Y surface 4401-05-05-0-05 without X port)

Mass [kg]	
DKZOR	5,0

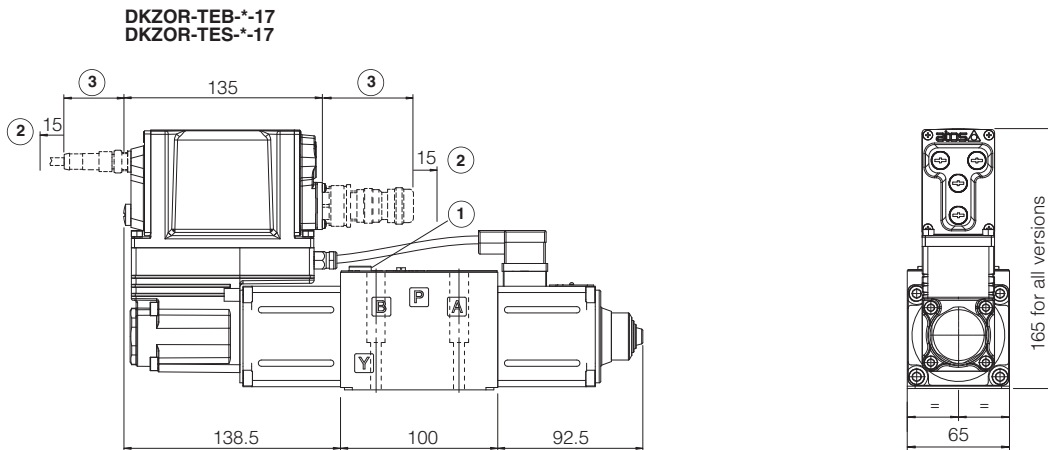

- ① = Air bleeding 4 13
- ② = Space to remove the connectors
- ③ = The dimensions of all connectors must be considered, see section 18.5 and 18.6

Note: for option /B the solenoid, the position transducer and the on-board digital driver are at side of port A

23 RELATED DOCUMENTATION

F002	Basics for digital electrohydraulics	GS500	Programming tools
F003	Commissioning and troubleshooting	GS510	Fieldbus
FS230	Digital proportional valves with integral axis controller	K500	Electric and electronic connectors
FY100	Safety proportional valves - option /U	P005	Mounting surfaces for electrohydraulic valves
FY200	Safety proportional valves - option /K	QB300	Quickstart for TEB valves commissioning
GS001	Basics for digital proportionals	QF300	Quickstart for TES valves commissioning
GS002	Basics for digital proportionals with P/Q control		
GS003	Settings for digital proportionals		