

# Servoproportional directional valves in sleeve execution

digital, direct operated, with LVDT transducer and zero spool overlap with fail safe

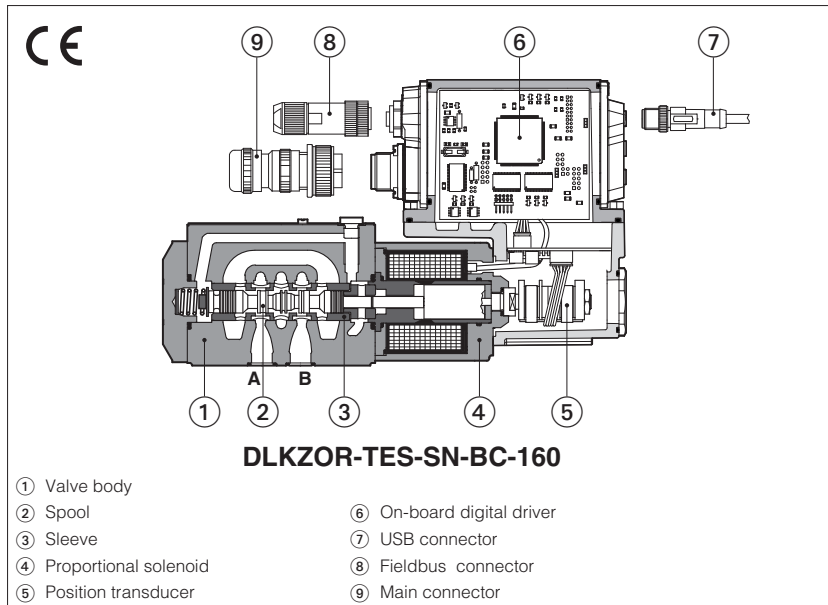

## DLHZO-TEB, DLHZO-TES DLKZOR-TEB, DLKZOR-TES

Digital servoproportional valves, direct operated in sleeve execution with LVDT position transducer and zero spool overlap for best performances in any position closed loop control.

**TEB** basic execution with analog reference signal and USB port for software functional parameters setting.

**TES** full execution which includes also optional alternated P/Q controls and fieldbus interfaces for functional parameters setting, reference signals and real-time diagnostics.

The on-board digital driver performs the valve's hydraulic regulation according to the reference signal and assures valve-to-valve interchangeability thanks to the factory presetting.

Digital TEZ version (see tech. table FS230) integrates on-board driver and axis card, while TEB and TES versions can be used in combination with Z-BM-KZ off-board axis card (see tech. table GS340).

**DLHZO:**  
Size: **06** - ISO 4401  
Max flow: **70 l/min**  
Max pressure: **350 bar**

**DLKZOR:**  
Size: **10** - ISO 4401  
Max flow: **160 l/min**  
Max pressure: **315 bar**

### 1 MODEL CODE

|   |   |            |   |           |   |           |   |          |           |   |          |          |          |   |   |   |   |
|---|---|------------|---|-----------|---|-----------|---|----------|-----------|---|----------|----------|----------|---|---|---|---|
| <b>DLHZO</b>  | - | <b>TES</b> | - | <b>SN</b> | - | <b>NP</b> | - | <b>0</b> | <b>40</b> | - | <b>L</b> | <b>7</b> | <b>3</b> | / | * | / | * |
| <p><b>DLHZO</b> = size 06<br/><b>DLKZOR</b> = size 10</p> <p><b>TEB</b> = basic on-board digital driver (1)<br/><b>TES</b> = full on-board digital driver</p> <p><b>Alternated P/Q controls</b>, see section 5:</p> <p><b>SN</b> = none<br/><b>SP</b> = pressure control (1 pressure transducer)<br/><b>SF</b> = force control (2 pressure transducers)<br/><b>SL</b> = force control (1 load cell)</p> <p><b>Fieldbus interfaces</b>, USB port always present:</p> <p><b>NP</b> = Not present<br/><b>BC</b> = CANopen<br/><b>BP</b> = PROFIBUS DP<br/><b>EH</b> = EtherCAT<br/><b>EW</b> = POWERLINK<br/><b>EI</b> = EtherNet/IP<br/><b>EP</b> = PROFINET RT/IRT</p> <p><b>Valve size ISO 4401:</b> <b>0</b> = 06    <b>1</b> = 10</p> |   |            |   |           |   |           |   |          |           |   |          |          |          |   |   |   |   |

### Alternated P/Q controls, see section 5:

**SN** = none  
**SP** = pressure control (1 pressure transducer)  
**SF** = force control (2 pressure transducers)  
**SL** = force control (1 load cell)

### Fieldbus interfaces, USB port always present:

**NP** = Not present  
**BC** = CANopen  
**BP** = PROFIBUS DP  
**EH** = EtherCAT  
**EW** = POWERLINK  
**EI** = EtherNet/IP  
**EP** = PROFINET RT/IRT

**Valve size ISO 4401:** **0** = 06    **1** = 10

### Configuration:

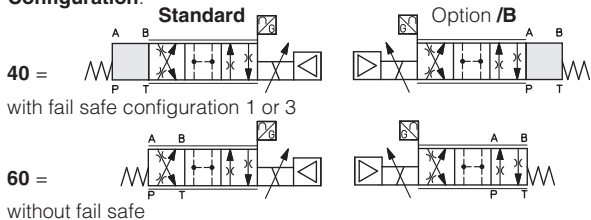

### Spool type, regulating characteristics:

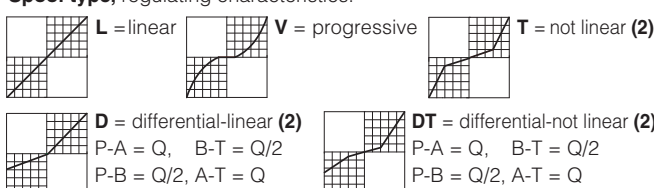

### Hydraulic options (3):

**B** = solenoid with on-board digital driver and position transducer at side of port A

**Y** = external drain

### Electronics options (3):

**C** = current feedback for pressure transducer 4÷20mA (omit for std voltage ±10Vdc) - only **TES-SP, SF, SL**

**F** = fault signal

**I** = current reference input and monitor 4÷20mA (omit for std voltage ±10Vdc)

**Q** = enable signal

**Z** = double power supply, enable, fault and monitor signals - 12 pin connector (4)

### Safety option TÜV certified - only TES (3):

**U** = safe double power supply

**K** = safe on/off acknowledge signals

See section 7



### Fail safe configuration, see section 13:

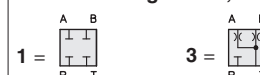

**Note:** select 1 for configuration 60 even without fail safe

### Spool size: 0 (L) 1 (L) 1 (V) 3 (L) 3 (V) 5 (L,T) 7 (L,T,V,D,DT)

DLHZO = 4    7    8    14    20    28    40

DLKZOR = -    -    -    60    -    -    100

Nominal flow (l/min) at Δp 70bar P-T

(1) Only in version **SN-NP**  
(2) Only for configuration **20**

(3) For possible combined options, see section 16  
(4) Double power supply only for **TES**

## 2 GENERAL NOTES

Atos digital proportionals valves are CE marked according to the applicable directives (e.g. Immunity and Emission EMC Directive). Installation, wirings and start-up procedures must be performed according to the general prescriptions shown in tech table **F003** and in the user manuals included in the E-SW-\* programming software.

## 3 VALVE SETTINGS AND PROGRAMMING TOOLS

Valve's functional parameters and configurations, can be easily set and optimized using Atos E-SW programming software connected via USB port to the digital driver (see table **GS003**). For fieldbus versions, the software permits valve's parameterization through USB port also if the driver is connected to the central machine unit via fieldbus.

The software is available in different versions according to the driver's options (see table **GS500**):

**E-SW-BASIC** support: NP (USB) PS (Serial) IR (Infrared)  
**E-SW-FIELDBUS** support: BC (CANopen) BP (PROFIBUS DP) EH (EtherCAT)  
 EW (POWERLINK) EI (EtherNet/IP) EP (PROFINET)  
**E-SW-\*/PQ** support: valves with SP, SF, SL alternated control (e.g. E-SW-BASIC/PQ)

**WARNING: drivers USB port is not isolated!** For E-C-SB-USB/M12 cable, the use of isolator adapter is highly recommended for PC protection

**WARNING: Bluetooth adapter is available only for European, USA and Canadian markets!** Bluetooth adapter is certified according RED (Europe), FCC (USA) and ISED (Canada) directives

### USB or Bluetooth connection

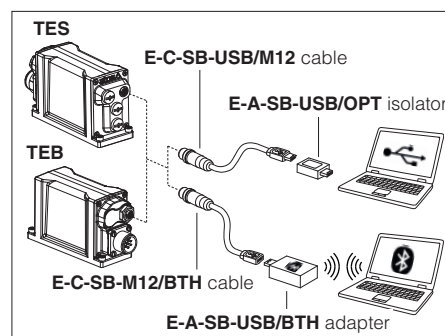

## 4 FIELDBUS - only for TES, see tech. table GS510

Fieldbus allows valve direct communication with machine control unit for digital reference, valve diagnostics and settings. These execution allow to operate the valves through fieldbus or analog signals available on the main connector.

## 5 ALTERNATED P/Q CONTROLS - only for TES, see tech. table GS002

**S\*** options add the closed loop control of pressure (**SP**) or force (**SF** and **SL**) to the basic functions of proportional directional valves flow regulation. A dedicated algorithm alternates pressure (force) depending on the actual hydraulic system conditions.

An additional connector is available for transducers to be interfaced to the valve's driver (1 pressure transducer for SP, 2 pressure transducers for SF or 1 load cell for SL). The alternated pressure control (SP) is possible only for specific installation conditions. Main 12 pin connector is the same as /Z option plus two analog signals specific for the pressure (force) control.

## 6 AXIS CONTROLLER - see tech. table FS230

Digital servoproportional with integral electronics **TEZ** include valve's driver plus axis controller, performing position closed loop of any hydraulic actuator equipped with analog, encoder or SSI position transducer. **S\*** option add alternated P/Q control to the basic position ones.

Atos also supplies complete servoactuators integrating servocylinder, digital servoproportional valve and axis controller, fully assembled and tested. For more information consult Atos Technical Office.

## 7 SAFETY OPTIONS - only for TES

Atos range of proportional directional valves, provides functional safety options **/U** and **/K**, designed to accomplish a safety function, intended to reduce the risk in process control systems.

They are **TÜV certified** in compliance to **IEC 61508 up to SIL 3** and **ISO 13849 up to category 4, PL e**

**Safe double power supply**, option **/U**: the driver has separate power supplies for logic and solenoids. The safe condition is reached by cutting the electrical supply to solenoids, while electronics remains active for monitoring functions and fieldbus communication, see tech table **FY100**

**Safety function via on/off signals**, option **/K**: upon a disable command, the driver checks the spool position and it provides an acknowledgement signal only when the valve is in safe condition, see tech table **FY200**



## 8 GENERAL CHARACTERISTICS

|  |   |
|--|---|
| Assembly position                      | Any position  |
| Subplate surface finishing to ISO 4401 | Acceptable roughness index: Ra ≤ 0,8, recommended Ra 0,4 – Flatness ratio 0,01/100                  |
| MTTFd valves according to EN ISO 13849 | 150 years, see technical table P007   |
| Ambient temperature range              | <b>Standard</b> = -20°C ÷ +60°C <b>/PE</b> option = -20°C ÷ +60°C <b>/BT</b> option = -40°C ÷ +60°C |
| Storage temperature range              | <b>Standard</b> = -20°C ÷ +70°C <b>/PE</b> option = -20°C ÷ +70°C <b>/BT</b> option = -40°C ÷ +70°C |
| Surface protection                     | Zinc coating with black passivation (body) galvanic treatment (driver housing)                      |
| Corrosion resistance                   | Salt spray test (EN ISO 9227) > 200 h   |
| Conformity                             | RoHs Directive 2011/65/EU as last update by 2015/65/EU<br>REACH Regulation (EC) n°1907/2006         |

**9 HYDRAULIC CHARACTERISTICS** - based on mineral oil ISO VG 46 at 50 °C

| Valve model                          | DLHZO  |           |           |           |           |           |           |           |           |           |            | DLKZOR   |           |           |           |           |            |
|--------------------------------------|--|-----------|-----------|-----------|-----------|-----------|-----------|-----------|-----------|-----------|------------|--|-----------|-----------|-----------|-----------|------------|
| Pressure limits [bar]                | ports <b>P, A, B</b> = 350;<br><b>T</b> = 210 (250 with external drain /Y) <b>Y</b> = 10 |           |           |           |           |           |           |           |           |           |            | ports <b>P, A, B</b> = 315;<br><b>T</b> = 210 (250 with external drain /Y) <b>Y</b> = 10 |           |           |           |           |            |
| Spool Type                           | <b>L0</b>  | <b>L1</b> | <b>V1</b> | <b>L3</b> | <b>V3</b> | <b>L5</b> | <b>T5</b> | <b>L7</b> | <b>T7</b> | <b>V7</b> | <b>DT7</b> | <b>L3</b>  | <b>L7</b> | <b>T7</b> | <b>V7</b> | <b>D7</b> | <b>DT7</b> |
| Nominal flow (1)<br>[l/min]          | 2,5  | 4,5       | 8         | 9         | 13        | 18        |           | 26        |           | 26÷13     |            | 40   | 60        |           | 60÷33     |           |            |
| $\Delta p$ P-T<br>$\Delta p= 30$ bar | 4  | 7         | 12        | 14        | 20        | 28        |           | 40        |           | 40÷20     |            | 60   | 100       |           | 100÷50    |           |            |
| Max flow                             | 8  | 14        | 16        | 30        | 40        | 50        |           | 70        |           | 70÷40     |            | 90   | 160       |           | 160÷80    |           |            |
| Leakage (2) [cm <sup>3</sup> /min]   | <100   | <200      | <100      | <300      | <150      | <500      | <200      | <900      | <200      | <700      | <200       | <1000  | <1500     | <400      | <400      | <1200     | <400       |
| Response time (3) [ms]               | ≤ 10   |           |           |           |           |           |           |           |           |           |            | ≤ 15   |           |           |           |           |            |
| Hysteresis                           | ≤ 0,1 [% of max regulation]  |           |           |           |           |           |           |           |           |           |            |  |           |           |           |           |            |
| Repeatability                        | ± 0,1 [% of max regulation]  |           |           |           |           |           |           |           |           |           |            |  |           |           |           |           |            |
| Thermal drift                        | zero point displacement < 1% at $\Delta T = 40^{\circ}C$                                 |           |           |           |           |           |           |           |           |           |            |  |           |           |           |           |            |

(1) For different  $\Delta p$ , the max flow is in accordance to the diagrams in section 12.2

(2) Referred to spool in neutral position and 50°C oil temperature

(3) 0-100% step signal

**10 ELECTRICAL CHARACTERISTICS**

|  |   |                                   |   |   |
|--|---|-----------------------------------|---|---|
| Power supplies   | Nominal : +24 VDC<br>Rectified and filtered : $V_{RMS} = 20 \div 32 V_{MAX}$ (ripple max 10 % VPP)  |                                   |   |   |
| Max power consumption  | 50 W  |                                   |   |   |
| Max. solenoid current  | <b>DLHZO</b> = 2,6 A  |                                   | <b>DLKZOR</b> = 3 A   |   |
| Coil resistance R at 20°C                                    | <b>DLHZO</b> = 3 ÷ 3,3 $\Omega$   |                                   | <b>DLKZOR</b> = 3,8 ÷ 4,1 $\Omega$  |   |
| Analog input signals   | Voltage: range ±10 VDC (24 VMAX tollerant)<br>Current: range ±20 mA   |                                   | Input impedance: $R_i > 50$ k $\Omega$<br>Input impedance: $R_i = 500$ $\Omega$ |   |
| Monitor outputs  | Output range: voltage ±10 VDC @ max 5 mA<br>current ±20 mA @ max 500 $\Omega$ load resistance   |                                   |   |   |
| Enable input   | Range: 0 ÷ 5 VDC (OFF state), 9 ÷ 24 VDC (ON state), 5 ÷ 9 VDC (not accepted); Input impedance: $R_i > 10$ k $\Omega$   |                                   |   |   |
| Fault output   | Output range: 0 ÷ 24 VDC (ON state > [power supply - 2 V] ; OFF state < 1 V ) @ max 50 mA;<br>external negative voltage not allowed (e.g. due to inductive loads)   |                                   |   |   |
| Pressure/Force transducer power supply (only for SP, SF, SL) | +24VDC @ max 100 mA (E-ATR-8 see tech table <b>GS465</b> )  |                                   |   |   |
| Alarms   | Solenoid not connected/short circuit, cable break with current reference signal, over/under temperature, valve spool transducer malfunctions, alarms history storage function   |                                   |   |   |
| Insulation class   | H (180°) Due to the occurring surface temperatures of the solenoid coils, the European standards ISO 13732-1 and EN982 must be taken into account   |                                   |   |   |
| Protection degree to DIN EN60529                             | IP66 / IP67 with mating connectors  |                                   |   |   |
| Duty factor  | Continuous rating (ED=100%)   |                                   |   |   |
| Tropicalization  | Tropical coating on electronics PCB   |                                   |   |   |
| Additional characteristics                                   | Short circuit protection of solenoid's current supply; 3 leds for diagnostic; spool position control (SN) or pressure/force control (SP, SF, SL) by P.I.D. with rapid solenoid switching; protection against reverse polarity of power supply |                                   |   |   |
| Electromagnetic compatibility (EMC)                          | According to Directive 2014/30/UE (Immunity: EN 61000-6-2; Emission: EN 61000-6-3)  |                                   |   |   |
| Communication interface                                      | USB<br>Atos ASCII coding  | CANopen<br>EN50325-4 + DS408      | PROFIBUS DP<br>EN50170-2/IEC61158   | EtherCAT, POWERLINK,<br>EtherNet/IP, PROFINET IO RT / IRT<br>EC 61158 |
| Communication physical layer                                 | not insulated<br>USB 2.0 + USB OTG  | optical insulated<br>CAN ISO11898 | optical insulated<br>RS485  | Fast Ethernet, insulated<br>100 Base TX                               |
| Recommended wiring cable                                     | LiYCY shielded cables, see section <a href="#">20</a>   |                                   |   |   |

**Note:** a maximum time of 800 ms (depending on communication type) have be considered between the driver energizing with the 24 Vdc power supply and when the valve is ready to operate. During this time the current to the valve coils is switched to zero.

**11 SEALS AND HYDRAULIC FLUIDS** - for other fluids not included in below table, consult our technical office

|                                      |   |  |  |
|--------------------------------------|---|--|--|
| Seals, recommended fluid temperature | NBR seals (standard) = -20°C ÷ +60°C, with HFC hydraulic fluids = -20°C ÷ +50°C<br>FKM seals (/PE option) = -20°C ÷ +80°C<br>HNBR seals (/BT option) = -40°C ÷ +60°C, with HFC hydraulic fluids = -40°C ÷ +50°C |  |  |
| Recommended viscosity                | 20÷100 mm <sup>2</sup> /s - max allowed range 15 ÷ 380 mm <sup>2</sup> /s   |  |  |
| Max fluid contamination level        | normal operation  | ISO4406 class 18/16/13 NAS1638 class 7 | see also filter section at <a href="http://www.atos.com">www.atos.com</a> or KTF catalog |
|                                      | longer life   | ISO4406 class 16/14/11 NAS1638 class 5 |  |
| <b>Hydraulic fluid</b>               | <b>Suitable seals type</b>  | <b>Classification</b>                  | <b>Ref. Standard</b>   |
| Mineral oils                         | NBR, FKM, HNBR  | HL, HLP, HLPD, HVLP, HVLDP             | DIN 51524  |
| Flame resistant without water        | FKM   | HFDU, HFDR                             | ISO 12922  |
| Flame resistant with water           | NBR, HNBR   | HFC                                    |  |

**12 DIAGRAMS** (based on mineral oil ISO VG 46 at 50 °C)

**12.1 Regulation diagrams**

- 1 = Linear spools L
- 2 = Differential - linear spool D7
- 3 = Differential non linear spool DT7
- 4 = Non linear spool T5 (only for DLHZO)
- 5 = Non linear spool T7
- 6 = Progressive spool V

T5 and T7 spool types are specific for fine low flow control in the range from 0 to 60% (T5) and 0 to 40% (T7) of max spool stroke.

The non linear characteristics of the spool is compensated by the electronic driver, so the final valve regulation is resulting linear respect the reference signal (dotted line).

DT7 has the same characteristic of T7 but it is specific for applications with cylinders with area ratio 1:2

**Note:**

Hydraulic configuration vs. reference signal:

**Standard:**

Reference signal  $\left. \begin{matrix} 0 \div +10 \text{ V} \\ 12 \div 20 \text{ mA} \end{matrix} \right\} P \rightarrow A / B \rightarrow T$

Reference signal  $\left. \begin{matrix} 0 \div -10 \text{ V} \\ 12 \div 4 \text{ mA} \end{matrix} \right\} P \rightarrow B / A \rightarrow T$

**option /B:**

Reference signal  $\left. \begin{matrix} 0 \div +10 \text{ V} \\ 12 \div 20 \text{ mA} \end{matrix} \right\} P \rightarrow B / A \rightarrow T$

Reference signal  $\left. \begin{matrix} 0 \div -10 \text{ V} \\ 12 \div 4 \text{ mA} \end{matrix} \right\} P \rightarrow A / B \rightarrow T$

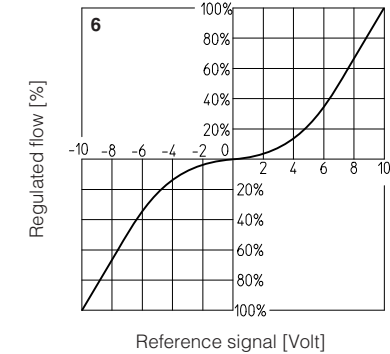
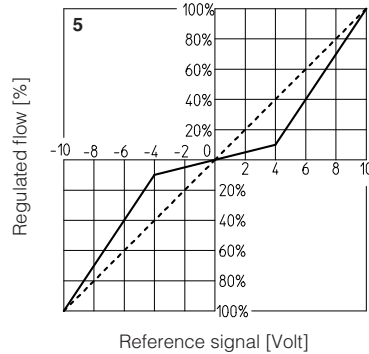
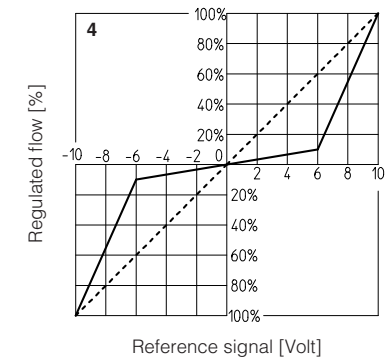
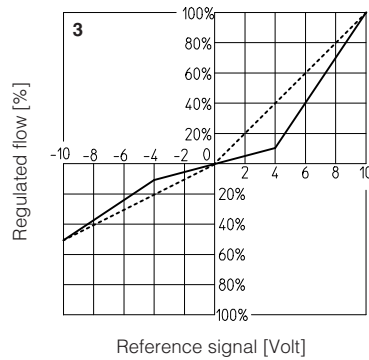
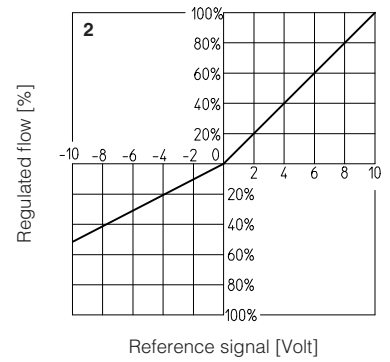
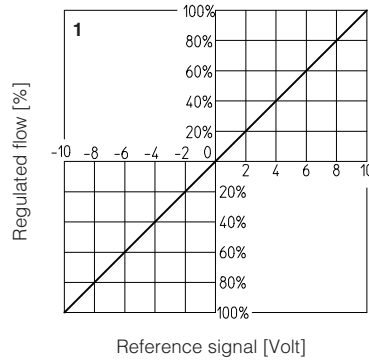

**12.2 Flow /Δp diagrams**

Stated at 100% of spool stroke

DLHZO:

- 1 = spool L7, T7, V7, D7, DT7
- 2 = spool L5, T5
- 3 = spool V3
- 4 = spool L3
- 5 = spool L1, V1
- 6 = spool L0

DLKZOR:

- 7 = spool L7, T7, V7, D7, DT7
- 8 = spool L3

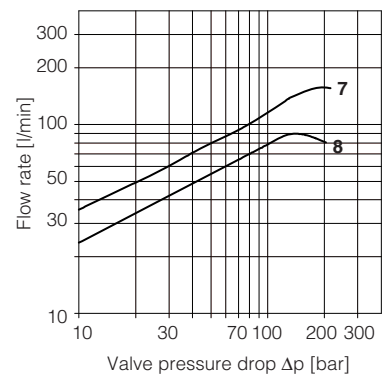
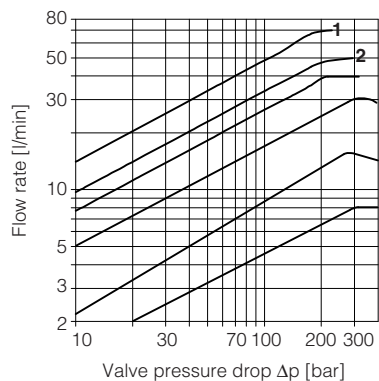

### 12.3 Pressure gain

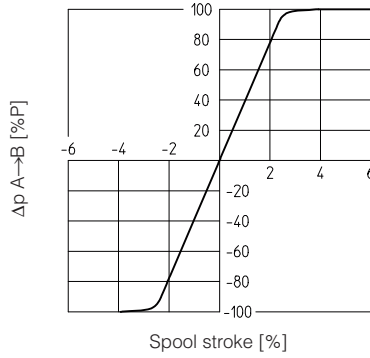
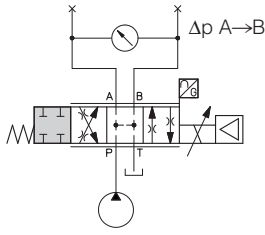

### 12.4 Response time

The response times in below diagrams are measured at different steps of the reference input signal. They have to be considered as average values. For the valves with digital electronics the dynamics performances can be optimized by setting the internal software parameters.

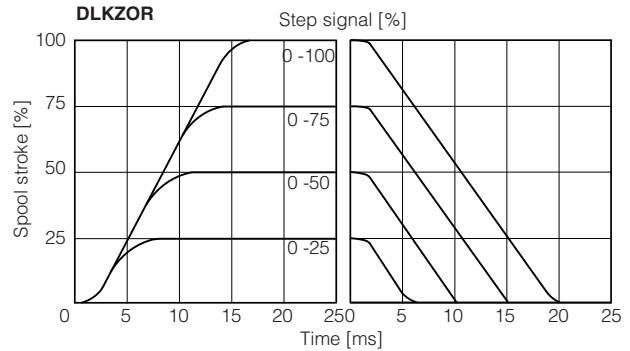
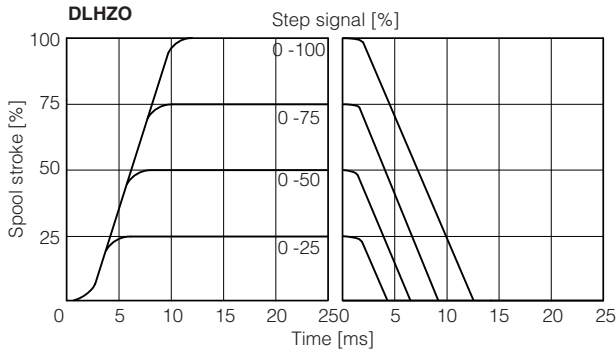

### 12.5 Bode diagrams

Stated at nominal hydraulic conditions

DLHZO:

- 1 = ± 100% nominal stroke
- 2 = ± 5% nominal stroke

DLKZOR:

- 3 = ± 100% nominal stroke
- 4 = ± 5% nominal stroke

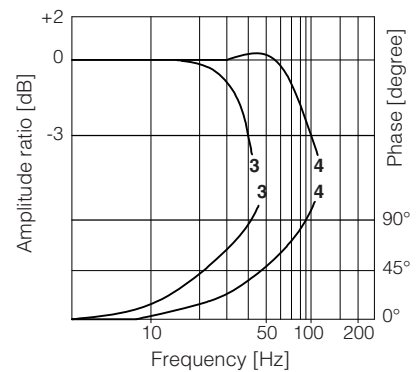
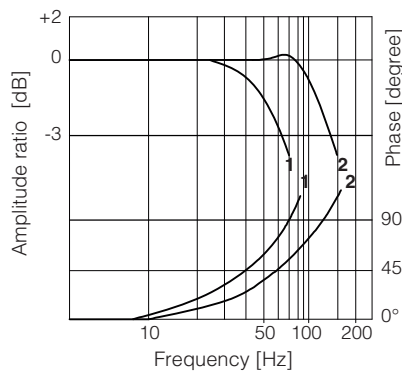

### 13 FAIL SAFE POSITION

| CONFIGURATION  | LINEAR  | NOT LINEAR   |
|--|---|--|
| <p>fail safe 1</p> <p>fail safe 3</p> <p>without fail safe</p> | <p><math>t = 7-10</math> ms (DLHZO)<br/><math>t = 15-20</math> ms (DLKZOR)</p>  | <p><math>t = 7-10</math> ms (DLHZO)<br/><math>t = 15-20</math> ms (DLKZOR)</p> |
|  | $t$ = time required by the valve to switch from central to fail safe position at the power switch-off, with pressure 0 to 100 bar |  |
|  |   |  |

| Fail safe connections                             |             | P → A | P → B | A → T | B → T |
|---|-------------|-------|-------|-------|-------|
| Leakage [cm <sup>3</sup> /min] at P = 100 bar (1) | Fail safe 1 | 50    | 70    | 70    | 50    |
|   | Fail safe 3 | 50    | 70    | -     | -     |
| Flow [l/min] (2)                                  | DLHZO       | -     | -     | 15÷30 | 10÷20 |
|   | DLKZOR      | -     | -     | 40÷60 | 25÷40 |

(1) Referred to spool in fail safe position and 50°C oil temperature

(2) Referred to spool in fail safe position at  $\Delta p = 35$  bar per edge

## 14 HYDRAULIC OPTIONS

**B** = Solenoid, on-board digital driver and position transducer at side of port A of the main stage. For hydraulic configuration vs reference signal, see 12.1  
**Y** = This option is mandatory if the pressure in port T exceeds 210 bar.

## 15 ELECTRONICS OPTIONS

**F** = This option permits to monitor the eventual fault condition of the driver, as for example the solenoid short circuit/not connected, reference signal cable broken for option /I, spool position transducer broken, etc. - see 17.9 for signal specifications.  
**I** = This option provides  $4 \div 20$  mA current reference and monitor signals, instead of the standard  $\pm 10$  VDC.  
Input signal can be reconfigured via software selecting between voltage and current, within a maximum range of  $\pm 10$  VDC or  $\pm 20$  mA.  
It is normally used in case of long distance between the machine control unit and the valve or where the reference signal can be affected by electrical noise; the valve functioning is disabled in case of reference signal cable breakage.  
**Q** = This option permits to inhibit the valve function without removing the power supply to the driver. Upon disable command the current to the solenoid is zeroed and the valve's spool moves to rest position.  
The option /Q is suggested for all cases where the valve has to be frequently inhibited during the machine cycle – see 17.7 for signal specifications.  
**Z** = This option provides, on the 12 pin main connector, the following additional features:  
**Fault output signal** - see above option /F  
**Enable input signal** - see above option /Q  
**Repeat enable output signal** - only for **TEB** (see 17.8)  
**Power supply for driver's logics and communication** - only for **TES** (see 17.2)  
**C** = This option is available to connect pressure (force) transducers with  $4 \div 20$  mA current output signal, instead of the standard  $\pm 10$  VDC.  
Input signal can be reconfigured via software selecting between voltage and current, within a maximum range of  $\pm 10$  VDC or  $\pm 20$  mA.

## 16 POSSIBLE COMBINED OPTIONS

### Standard versions for **TEB-SN** and **TES-SN**:

/BF, /BFI, /BFIY, /BFY, /BI, /BIQ, /BIQY, /BIY, /BIYZ, /BIZ, /BQ,  
/BQY /BY, /BYZ, /BZ,  
/FI, /FIY, /FY,  
/IQ, /IQY, /IY, /IYZ, /IZ,  
/QY, /YZ

### Standard versions for **TES-SP, SF, SL**:

/BC, /BCI, /BCIY, /BCY, /BI, /BIY, /BY,  
/CI, /CIY, /CY,  
/IY

### Safety certified versions for **TES-SN**:

/BIU, /BIUY, /BU, /BUY, /IU, /IUY, /UY,  
/BIK, /BIKY, /BK, /BKY, /IK, /IKY, /KY

### Safety certified versions for **TES-SP, SF, SL**:

/BCU, /BCIU, /BCIUY, /BCUY, /BIU, /BIUY, /BU, /BUY,  
/CU, /CIU, /CIUY, /CUY, /IU, /IUY, /UY,  
/BCK, /BCKI, /BCKY, /BIK, /BIKY, /BK, /BKY,  
/CK, /CIK, /CIKY, /CKY, /IK, /IKY, /KY

## 17 POWER SUPPLY AND SIGNALS SPECIFICATIONS

Generic electrical output signals of the valve (e.g. fault or monitor signals) must not be directly used to activate safety functions, like to switch-ON/OFF the machine's safety components, as prescribed by the European standards (Safety requirements of fluid technology systems and components-hydraulics, EN-982).

For certified safety options: /U see tech. table **FY100** and /K see tech. table **FY200**

### 17.1 Power supply (V+ and V0)

The power supply must be appropriately stabilized or rectified and filtered: apply at least a 10000  $\mu$ F/40 V capacitance to single phase rectifiers or a 4700  $\mu$ F/40 V capacitance to three phase rectifiers. In case of separate power supply see 17.2.



A safety fuse is required in series to each power supply: 2,5 A time lag fuse.

### 17.2 Power supply for driver's logic and communication (VL+ and VL0) - only for /Z option and **TES-SP, SF, SL** with fieldbus

The power supply for driver's logic and communication must be appropriately stabilized or rectified and filtered: apply at least a 10000  $\mu$ F/40 V capacitance to single phase rectifiers or a 4700  $\mu$ F/40 V capacitance to three phase rectifiers.

The separate power supply for driver's logic on pin 9 and 10, allow to remove solenoid power supply from pin 1 and 2 maintaining active the diagnostics, USB and fieldbus communications.



A safety fuse is required in series to each driver's logic and communication power supply: 500 mA fast fuse.

### 17.3 Flow reference input signal (Q\_INPUT+)

The driver controls in closed loop the valve spool position proportionally to the external reference input signal.

Reference input signal is factory preset according to selected valve code, defaults are  $\pm 10$  VDC for standard and  $4 \div 20$  mA for /I option.

Input signal can be reconfigured via software selecting between voltage and current, within a maximum range of  $\pm 10$  VDC or  $\pm 20$  mA.

Drivers with fieldbus interface can be software set to receive reference signal directly from the machine control unit (fieldbus reference). Analog reference input signal can be used as on-off commands with input range  $0 \div 24$ VDC.

### 17.4 Pressure or force reference input signal (F\_INPUT+) - only for **TES-SP, SF, SL**

Functionality of F\_INPUT+ signal (pin 7), is used as reference for the driver pressure/force closed loop (see tech. table **GS002**).

Reference input signal is factory preset according to selected valve code, defaults are  $\pm 10$  Vdc for standard and  $4 \div 20$  mA for /I option.

Input signal can be reconfigured via software selecting between voltage and current, within a maximum range of  $\pm 10$  VDC or  $\pm 20$  mA.

Drivers with fieldbus interface can be software set to receive reference signal directly by the machine control unit (fieldbus reference).

Analog reference input signal can be used as on-off commands with input range  $0 \div 24$ VDC.

### 17.5 Flow monitor output signal (Q\_MONITOR) - not for /F

The driver generates an analog output signal proportional to the actual spool position of the valve; the monitor output signal can be software set to show other signals available in the driver (e.g. analog reference, fieldbus reference, pilot spool position).

Monitor output signal is factory preset according to selected valve code, defaults are  $\pm 10$  VDC for standard and  $4 \div 20$  mA for /I option.

Output signal can be reconfigured via software selecting between voltage and current, within a maximum range of  $\pm 10$  VDC or  $\pm 20$  mA.

### 17.6 Pressure or force monitor output signal (F\_MONITOR) - only for **TES-SP, SF, SL**

The driver generates an analog output signal proportional to alternated pressure/force control; the monitor output signal can be software set to show other signals available in the driver (e.g. analog reference, force reference).

Monitor output signal is factory preset according to selected valve code, defaults are  $\pm 10$  VDC for standard and  $4 \div 20$  mA for /I option.

Output signal can be reconfigured via software selecting between voltage and current, within a maximum range of  $\pm 10$  VDC or  $\pm 20$  mA.

**17.7 Enable input signal (ENABLE) - not for standard and /F**

To enable the driver, supply a 24 Vdc on pin 3 (pin C): Enable input signal allows to enable/disable the current supply to the solenoid, without removing the electrical power supply to the driver; it is used to active the communication and the other driver functions when the valve must be disabled for safety reasons. This condition **does not comply** with norms IEC 61508 and ISO 13849. Enable input signal can be used as generic digital input by software selection.

**17.8 Repeat enable output signal (R\_ENABLE) - only for TEB with /Z option**

Repeat enable is used as output repeater signal of enable input signal (see 17.7).

**17.9 Fault output signal (FAULT) - not for standard and /Q**

Fault output signal indicates fault conditions of the driver (solenoid short circuits/not connected, reference signal cable broken for 4 ÷ 20 mA input, spool position transducer cable broken, etc.). Fault presence corresponds to 0 Vdc, normal working corresponds to 24 Vdc. Fault status is not affected by the Enable input signal. Fault output signal can be used as digital output by software selection.

**17.10 Remote pressure/force transducer input signal - only for TES-SP, SF, SL**

Analog remote pressure transducers or load cell can be directly connected to the driver (see 18.4).

Analog input signal is factory preset according to selected valve code, defaults are ±10 Vdc for standard and 4 ÷ 20 mA for /C option.

Input signal can be reconfigured via software selecting between voltage and current, within a maximum range of ±10 Vdc or ± 20 mA.

Refer to pressure/force transducer characteristics to select the transducer type according to specific application requirements (see tech table **GS002**).

**17.11 Multiple PID selection (D\_IN0 and D\_IN1) - only NP execution for TES-SP, SF, SL**

Two on-off input signals are available on the main connector to select one of the four pressure (force) PID parameters setting, stored into the driver.

Switching the active setting of pressure PID during the machine cycle allows to optimize the system dynamic response in different hydraulic working conditions (volume, flow, etc.).

Supply a 24 Vdc or a 0 Vdc on pin 9 and/or pin 10, to select one of the PID settings as indicated by binary code table at side. Gray code can be selected by software.

| PID SET SELECTION |       |        |        |        |
|-------------------|-------|--------|--------|--------|
| PIN               | SET 1 | SET 2  | SET 3  | SET 4  |
| 9                 | 0     | 24 Vdc | 0      | 24 Vdc |
| 10                | 0     | 0      | 24 Vdc | 24 Vdc |

**18 ELECTRONIC CONNECTIONS**

**18.1 Main connector signals - 7 pin (A1) Standard, /Q and /F options**

| PIN | Standard                      | /Q            | /F           | TECHNICAL SPECIFICATIONS   | NOTES  |
|-----|-------------------------------|---------------|--------------|--|--|
| A   | <b>V+</b>                     |               |              | Power supply 24 Vdc  | Input - power supply                                 |
| B   | <b>V0</b>                     |               |              | Power supply 0 Vdc   | Gnd - power supply                                   |
| C   | <b>AGND</b>                   |               | <b>AGND</b>  | Analog ground  | Gnd - analog signal                                  |
|     |                               | <b>ENABLE</b> |              | Enable (24 Vdc) or disable (0 Vdc) the valve, referred to V0   | Input - on/off signal                                |
| D   | <b>Q_INPUT+</b>               |               |              | Flow reference input signal: ±10 Vdc / ±20 mA maximum range<br>Defaults are ±10 Vdc for standard and 4 ÷ 20 mA for /I option | Input - analog signal<br><b>Software selectable</b>  |
| E   | <b>INPUT-</b>                 |               |              | Negative reference input signal for Q_INPUT+   | Input - analog signal                                |
| F   | <b>Q_MONITOR</b> referred to: |               |              | Flow monitor output signal: ±10 Vdc / ±20 mA maximum range<br>Defaults are ±10 Vdc for standard and 4 ÷ 20 mA for /I option  | Output - analog signal<br><b>Software selectable</b> |
|     | AGND                          | V0            |              |  |  |
|     |                               |               | <b>FAULT</b> | Fault (0 Vdc) or normal working (24 Vdc)   | Output - on/off signal                               |
| G   | <b>EARTH</b>                  |               |              | Internally connected to the driver housing   |  |

**18.2 Main connector signals - 12 pin (A2) /Z option and TES-SP, SF, SL**

| PIN | TEB-SN /Z                     | TES-SN /Z  | TES-SP, SF, SL<br>Fieldbus NP |              | TECHNICAL SPECIFICATIONS   | NOTES  |
|-----|-------------------------------|------------|-------------------------------|--------------|--|--|
| 1   | <b>V+</b>                     |            |                               |              | Power supply 24 Vdc  | Input - power supply                                 |
| 2   | <b>V0</b>                     |            |                               |              | Power supply 0 Vdc   | Gnd - power supply                                   |
| 3   | <b>ENABLE</b> referred to:    |            |                               |              | Enable (24 Vdc) or disable (0 Vdc) the valve   | Input - on/off signal                                |
|     | V0                            | VL0        | VL0                           | V0           |  |  |
| 4   | <b>Q_INPUT+</b>               |            |                               |              | Flow reference input signal: ±10 Vdc / ±20 mA maximum range<br>Defaults are ±10 Vdc for standard and 4 ÷ 20 mA for /I option           | Input - analog signal<br><b>Software selectable</b>  |
| 5   | <b>INPUT-</b>                 |            |                               |              | Negative reference input signal for Q_INPUT+ and F_INPUT+  | Input - analog signal                                |
| 6   | <b>Q_MONITOR</b> referred to: |            |                               |              | Flow monitor output signal: ±10 Vdc / ±20 mA maximum range<br>Defaults are ±10 Vdc for standard and 4 ÷ 20 mA for /I option            | Output - analog signal<br><b>Software selectable</b> |
|     | AGND                          | VL0        | VL0                           | V0           |  |  |
| 7   | <b>AGND</b>                   |            |                               |              | Analog ground  | Gnd - analog signal                                  |
|     |                               | <b>NC</b>  |                               |              | Do not connect   |  |
|     |                               |            | <b>F_INPUT+</b>               |              | Pressure/Force reference input signal: ±10 Vdc / ±20 mA maximum range<br>Defaults are ±10 Vdc for standard and 4 ÷ 20 mA for /I option | Input - analog signal<br><b>Software selectable</b>  |
|     | <b>R_ENABLE</b>               |            |                               |              | Repeat enable, output repeter signal of enable input, referred to V0   | Output - on/off signal                               |
| 8   |                               | <b>NC</b>  |                               |              | Do not connect   |  |
|     |                               |            | <b>F_MONITOR</b> referred to: |              | Pressure/Force monitor output signal: ±10 Vdc / ±20 mA maximum range<br>Defaults are ±10 Vdc for standard and 4 ÷ 20 mA for /I option  | Output - analog signal<br><b>Software selectable</b> |
|     |                               |            | VL0                           | V0           |  |  |
| 9   | <b>NC</b>                     |            |                               |              | Do not connect   |  |
|     |                               | <b>VL+</b> |                               |              | Power supply 24 Vdc for driver's logic and communication   | Input - power supply                                 |
|     |                               |            |                               | <b>D_IN0</b> | Multiple pressure/force PID selection, referred to V0  | Input - analog signal                                |
| 10  | <b>NC</b>                     |            |                               |              | Do not connect   |  |
|     |                               | <b>VL0</b> |                               |              | Power supply 0 Vdc for driver's logic and communication  | Gnd - power supply                                   |
|     |                               |            |                               | <b>D_IN1</b> | Multiple pressure/force PID selection (not available for SF), referred to V0   | Input - on/off signal                                |
| 11  | <b>FAULT</b> referred to:     |            |                               |              | Fault (0 Vdc) or normal working (24 Vdc)   | Output - on/off signal                               |
|     | V0                            | VL0        | VL0                           | V0           |  |  |
| PE  | <b>EARTH</b>                  |            |                               |              | Internally connected to the driver housing   |  |

**Note:** do not disconnect VL0 before VL+ when the driver is connected to PC USB port

### 18.3 Communications connectors (B) - (C)

| (B) USB connector - M12 - 5 pin always present |         |                             |
|--|---------|-----------------------------|
| PIN  | SIGNAL  | TECHNICAL SPECIFICATION (1) |
| 1  | +5V_USB | Power supply                |
| 2  | ID      | Identification              |
| 3  | GND_USB | Signal zero data line       |
| 4  | D-      | Data line -                 |
| 5  | D+      | Data line +                 |

| (C1) (C2) BP fieldbus execution, connector - M12 - 5 pin |        |                                       |
|--|--------|---------------------------------------|
| PIN  | SIGNAL | TECHNICAL SPECIFICATION (1)           |
| 1  | +5V    | Termination supply signal             |
| 2  | LINE-A | Bus line (high)                       |
| 3  | DGND   | Data line and termination signal zero |
| 4  | LINE-B | Bus line (low)                        |
| 5  | SHIELD |                                       |

(1) Shield connection on connector's housing is recommended

| (C1) (C2) BC fieldbus execution, connector - M12 - 5 pin |          |   |
|--|----------|---|
| PIN  | SIGNAL   | TECHNICAL SPECIFICATION (1)             |
| 1  | CAN_SHLD | Shield                                  |
| 2  | not used | (C1) - (C2) pass-through connection (2) |
| 3  | CAN_GND  | Signal zero data line                   |
| 4  | CAN_H    | Bus line (high)                         |
| 5  | CAN_L    | Bus line (low)                          |

| (C1) (C2) EH, EW, EI, EP fieldbus execution, connector - M12 - 4 pin |        |                             |
|--|--------|-----------------------------|
| PIN  | SIGNAL | TECHNICAL SPECIFICATION (1) |
| 1  | TX+    | Transmitter                 |
| 2  | RX+    | Receiver                    |
| 3  | TX-    | Transmitter                 |
| 4  | RX-    | Receiver                    |
| Housing  | SHIELD |                             |

(2) Pin 2 can be fed with external +5V supply of CAN interface

### 18.4 Remote pressure/force transducer connector - M12 - 5 pin - only for SP, SF, SL (D)

| PIN | SIGNAL  | TECHNICAL SPECIFICATION                                  | NOTES   | (D1) SP, SL - Single transducer (1) |         | (D2) SF - Double transducers (1) |         |
|-----|---------|--|---|-------------------------------------|---------|----------------------------------|---------|
|     |         |  |   | Voltage                             | Current | Voltage                          | Current |
| 1   | VF +24V | Power supply +24Vdc                                      | Output - power supply                               | Connect                             | Connect | Connect                          | Connect |
| 2   | TR1     | 1st signal transducer:<br>±10 Vdc / ±20 mA maximum range | Input - analog signal<br><b>Software selectable</b> | Connect                             | Connect | Connect                          | Connect |
| 3   | AGND    | Common gnd for transducer power and signals              | Common gnd  | Connect                             | /       | Connect                          | /       |
| 4   | TR2     | 2nd signal transducer:<br>±10 Vdc / ±20 mA maximum range | Input - analog signal<br><b>Software selectable</b> | /                                   | /       | Connect                          | Connect |
| 5   | NC      | Not connect  |   | /                                   | /       | /                                | /       |

(1) Single/double transducer configuration is software selectable

### Remote pressure transducers connection - example

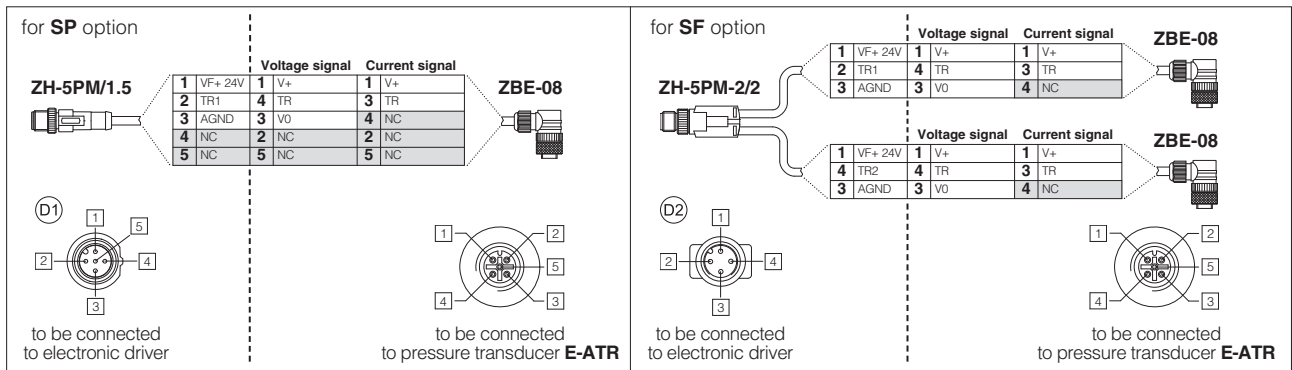

Note: pin layout always referred to driver's view

### 18.5 TEB connections layout

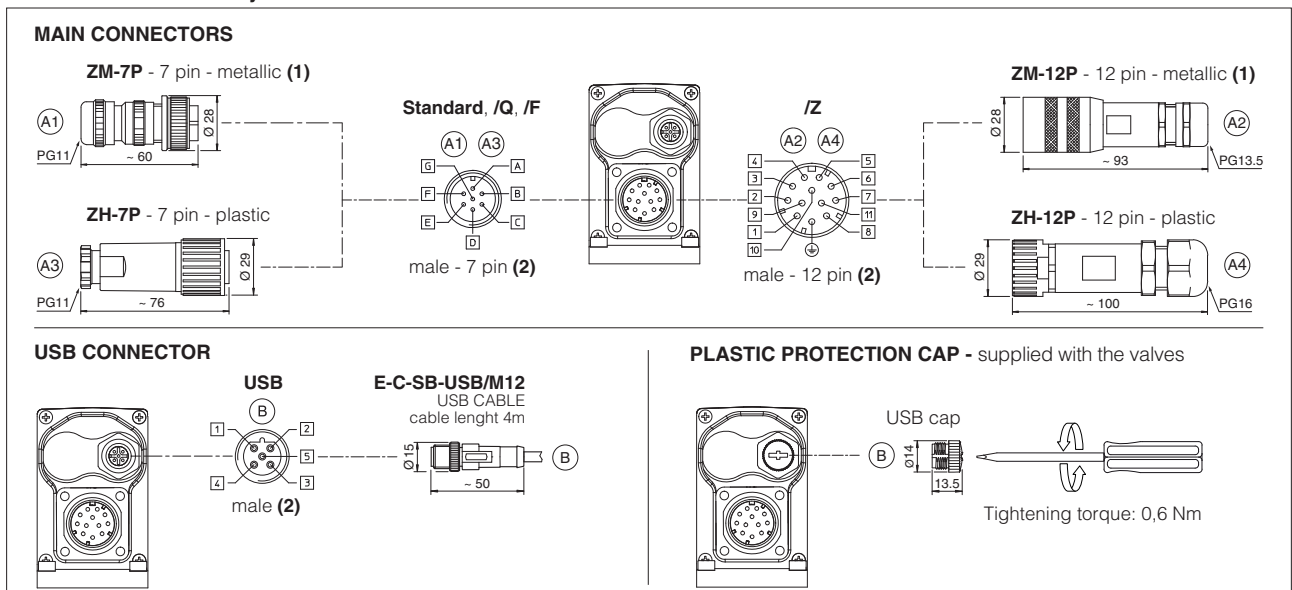

(1) Use of metallic connectors is strongly recommended in order to fulfill EMC requirements

(2) Pin layout always referred to driver's view

## 18.6 TES connections layout

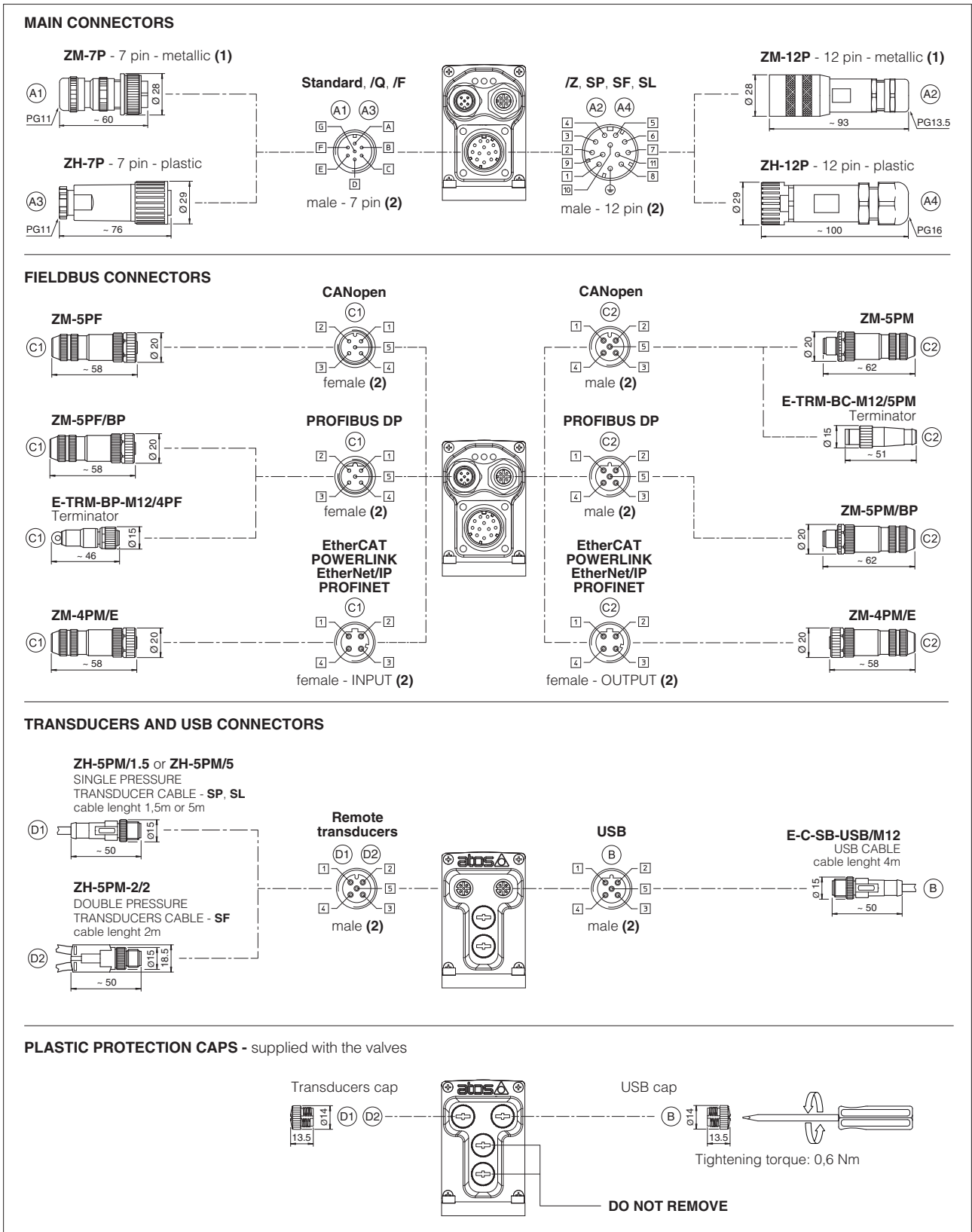

(1) Use of metallic connectors is strongly recommended in order to fulfill EMC requirements (2) Pin layout always referred to driver's view

## 18.7 Diagnostic LEDs - only for TES

Three leds show driver operative conditions for immediate basic diagnostics. Please refer to the driver user manual for detailed information.

| FIELDBUS<br>LEDS | NP<br>Not Present | BC<br>CANopen   | BP<br>PROFIBUS DP | EH<br>EtherCAT | EW<br>POWERLINK | EI<br>EtherNet/IP | EP<br>PROFINET | L1 L2 L3 |
|------------------|-------------------|-----------------|-------------------|----------------|-----------------|-------------------|----------------|----------|
| L1               |                   | VALVE STATUS    |                   |                | LINK/ACT        |                   |                |          |
| L2               |                   | NETWORK STATUS  |                   |                | NETWORK STATUS  |                   |                |          |
| L3               |                   | SOLENOID STATUS |                   |                | LINK/ACT        |                   |                |          |

## 19 IN / OUT FIELDBUS COMMUNICATION CONNECTORS

Two fieldbus communication connectors are always available for digital drivers executions BC, BP, EH, EW, EI, EP. This features allows considerable technical advantages in terms of installation simplicity, wirings reduction and also avoid the usage expensive T-connectors.

For BC and BP executions the fieldbus connectors have an internal pass-through connection and can be used like end point of the fieldbus network, using an external terminator (see tech table **GS500**).

For EH, EW, EI and EP executions the external terminators are not required: each connector is internally terminated.

### BC and BP pass-through connection

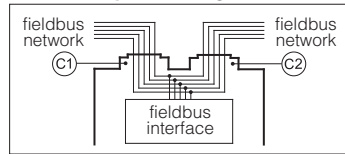

## 20 CONNECTORS CHARACTERISTICS - to be ordered separately

### 20.1 Main connectors - 7 pin

| CONNECTOR TYPE        | POWER SUPPLY  | POWER SUPPLY  |
|-----------------------|---|---|
| <b>CODE</b>           | (A1) <b>ZM-7P</b>   | (A3) <b>ZH-7P</b>   |
| Type                  | 7pin female straight circular   | 7pin female straight circular   |
| Standard              | According to MIL-C-5015   | According to MIL-C-5015   |
| Material              | Metallic  | Plastic reinforced with fiber glass   |
| Cable gland           | PG11  | PG11  |
| Recommended cable     | LiYCY 7 x 0,75 mm <sup>2</sup> max 20 m (logic and power supply) or LiYCY 7 x 1 mm <sup>2</sup> max 40 m (logic and power supply) | LiYCY 7 x 0,75 mm <sup>2</sup> max 20 m (logic and power supply) or LiYCY 7 x 1 mm <sup>2</sup> max 40 m (logic and power supply) |
| Conductor size        | up to 1 mm <sup>2</sup> - available for 7 wires   | up to 1 mm <sup>2</sup> - available for 7 wires   |
| Connection type       | to solder   | to solder   |
| Protection (EN 60529) | IP 67   | IP 67   |

### 20.2 Main connectors - 12 pin

| CONNECTOR TYPE        | POWER SUPPLY  | POWER SUPPLY  |
|-----------------------|---|---|
| <b>CODE</b>           | (A2) <b>ZM-12P</b>  | (A4) <b>ZH-12P</b>  |
| Type                  | 12pin female straight circular                                      | 12pin female straight circular  |
| Standard              | DIN 43651   | DIN 43651   |
| Material              | Metallic  | Plastic reinforced with fiber glass   |
| Cable gland           | PG13,5  | PG16  |
| Recommended cable     | LiYCY 12 x 0,75 mm <sup>2</sup> max 20 m (logic and power supply)   | LiYCY 10 x 0,14mm <sup>2</sup> max 40 m (logic)<br>LiYY 3 x 1mm <sup>2</sup> max 40 m (power supply)                                      |
| Conductor size        | 0,5 mm <sup>2</sup> to 1,5 mm <sup>2</sup> - available for 12 wires | 0,14 mm <sup>2</sup> to 0,5 mm <sup>2</sup> - available for 9 wires<br>0,5 mm <sup>2</sup> to 1,5 mm <sup>2</sup> - available for 3 wires |
| Connection type       | to crimp  | to crimp  |
| Protection (EN 60529) | IP 67   | IP 67   |

### 20.3 Fieldbus communication connectors

| CONNECTOR TYPE        | BC CANopen (1)                       |                              | BP PROFIBUS DP (1)                   |                              | EH EtherCAT, EW POWERLINK, EI EtherNet/IP, EP PROFINET (2) |  |
|-----------------------|--------------------------------------|------------------------------|--------------------------------------|------------------------------|--|--|
| <b>CODE</b>           | (C1) <b>ZM-5PF</b>                   | (C2) <b>ZM-5PM</b>           | (C1) <b>ZM-5PF/BP</b>                | (C2) <b>ZM-5PM/BP</b>        | (C1) (C2) <b>ZM-4PM/E</b>                                  |  |
| Type                  | 5 pin female straight circular       | 5 pin male straight circular | 5 pin female straight circular       | 5 pin male straight circular | 4 pin male straight circular                               |  |
| Standard              | M12 coding A – IEC 61076-2-101       |                              | M12 coding B – IEC 61076-2-101       |                              | M12 coding D – IEC 61076-2-101                             |  |
| Material              | Metallic                             |                              | Metallic                             |                              | Metallic   |  |
| Cable gland           | Pressure nut - cable diameter 6÷8 mm |                              | Pressure nut - cable diameter 6÷8 mm |                              | Pressure nut - cable diameter 4÷8 mm                       |  |
| Cable                 | CANbus Standard (DR 303-1)           |                              | PROFIBUS DP Standard                 |                              | Ethernet standard CAT-5                                    |  |
| Connection type       | screw terminal                       |                              | screw terminal                       |                              | terminal block   |  |
| Protection (EN 60529) | IP67                                 |                              | IP 67                                |                              | IP 67  |  |



(1) E-TRM-\*\* terminators can be ordered separately - see tech table **GS500**

(2) Internally terminated

### 20.4 Pressure/Force transducer connectors - only for SP, SF, SL

| CONNECTOR TYPE        | SP, SL - Single transducer                               |                      | SF - Double transducers                |
|-----------------------|--|----------------------|--|
| <b>CODE</b>           | (D1) <b>ZH-5PM/1.5</b>                                   | (D1) <b>ZH-5PM/5</b> | (D2) <b>ZH-5PM-2/2</b>                 |
| Type                  | 5 pin male straight circular                             |                      | 4 pin male straight circular           |
| Standard              | M12 coding A – IEC 61076-2-101                           |                      | M12 coding A – IEC 61076-2-101         |
| Material              | Plastic  |                      | Plastic                                |
| Cable gland           | Connector moulded on cables<br>1,5 m lenght   5 m lenght |                      | Connector moulded on cables 2 m lenght |
| Cable                 | 5 x 0,25 mm <sup>2</sup>                                 |                      | 3 x 0,25 mm <sup>2</sup> (both cables) |
| Connection type       | molded cable   |                      | splitting cable                        |
| Protection (EN 60529) | IP 67  |                      | IP 67                                  |

## 21 FASTENING BOLTS AND SEALS

|   | DLHZO  | DLKZOR  |
|---|--|---|
|  | <b>Fastening bolts:</b><br>4 socket head screws M5x50 class 12.9<br>Tightening torque = 8 Nm   | <b>Fastening bolts:</b><br>4 socket head screws M6x40 class 12.9<br>Tightening torque = 15 Nm   |
|  | <b>Seals:</b><br>4 OR 108;<br>Diameter of ports A, B, P, T: Ø 7,5 mm (max)<br>1 OR 2025<br>Diameter of port Y: Ø = 3,2 mm (only for /Y option) | <b>Seals:</b><br>5 OR 2050;<br>Diameter of ports A, B, P, T: Ø 11,2 mm (max)<br>1 OR 108<br>Diameter of port Y: Ø = 5 mm (only for /Y option) |

### DLHZO-TEB, DLHZO-TES

ISO 4401: 2000  
 Mounting surface: 4401-03-02-0-05 (see table P005)  
 (for /Y surface 4401-03-03-0-05 without X port)

| Mass [kg] |     |
|-----------|-----|
| DLHZO     | 2,3 |

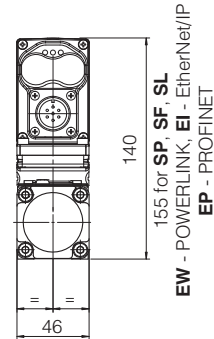
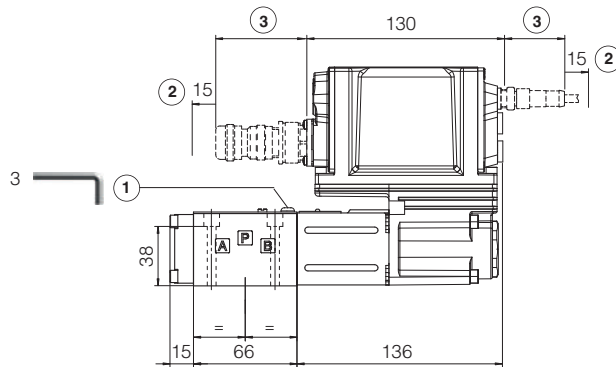

### DLKZOR-TEB, DLKZOR-TES

ISO 4401: 2000  
 Mounting surface: 4401-05-04-0-05 (see table P005)  
 (for /Y surface 4401-05-05-0-05 without X port)

| Mass [kg] |     |
|-----------|-----|
| DLKZOR    | 4,3 |

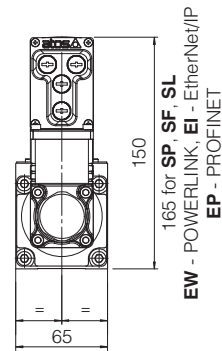
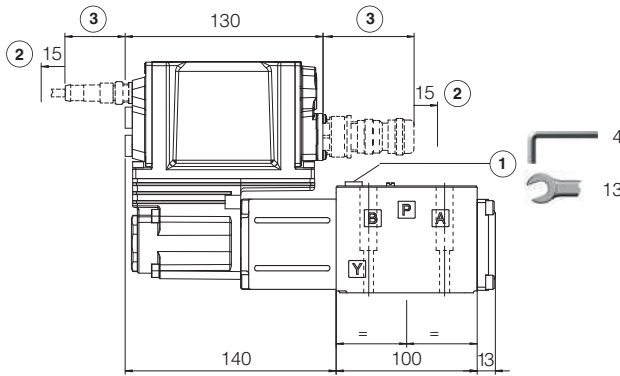

- ① = Air bleeding
- ② = Space to remove the connectors
- ③ = The dimensions of all connectors must be considered, see section 18.5 and 18.6

**Note:** for option /B the solenoid, the position transducer and the on-board digital driver are at side of port A

### 23 RELATED DOCUMENTATION

|              |   |              |   |
|--------------|---|--------------|---|
| <b>F002</b>  | Basics for digital electrohydraulics                      | <b>GS500</b> | Programming tools                             |
| <b>F003</b>  | Commissioning and troubleshooting                         | <b>GS510</b> | Fieldbus                                      |
| <b>FS230</b> | Digital proportional valves with integral axis controller | <b>K500</b>  | Electric and electronic connectors            |
| <b>FY100</b> | Safety proportional valves - option /U                    | <b>P005</b>  | Mounting surfaces for electrohydraulic valves |
| <b>FY200</b> | Safety proportional valves - option /K                    | <b>QB300</b> | Quickstart for TEB valves commissioning       |
| <b>GS001</b> | Basics for digital proportionals                          | <b>QF300</b> | Quickstart for TES valves commissioning       |
| <b>GS002</b> | Basics for digital proportionals with P/Q control         |              |   |
| <b>GS003</b> | Settings for digital proportionals                        |              |   |